



Jouplast®

INNOVATIVE
SOLUTIONS
FOR
OUTDOOR SPACES

PATHS, DRIVEWAYS AND PARKING SPACES

GARDEN LANDSCAPING

TERRACES

WOODEN DECKING



www.jouplast.com





CONTENTS

EDITORIAL	p. 4
OUR ECO-COMMITMENT	p. 5
SOLUTIONS FOR PATHS, DRIVEWAYS AND PARKING SPACES	p. 6
SOLUTIONS FOR GARDEN LANDSCAPING ...	p. 14
SOLUTIONS FOR TERRACES	p. 20
SOLUTIONS FOR WOODEN DECKING	p. 44
PRODUCT ENVIRONMENT INFORMATION	p. 62
TECHNICAL SUPPORT	p. 64
SALES CONTACTS	p. 65
CALCULATE THE NUMBER OF RISERS YOU NEED PER M²	p. 66
RISER POSITIONING	p. 67

EDITORIAL

We believe that innovation knows no limits, and are totally committed to that philosophy.

Our mission at TMP CONVERT is to take outdoor landscaping to a new level, and develop easy-to-use products that are equally suitable for homeowner and professional use.

The information contained in this catalogue is designed to give you all the information and explanations you need to make your project a reality. The Jouplast® range has been developed to offer you the broad range of products you need for your landscaping projects, from terraces and decking to garden landscaping, traffic areas, driveways and parking spaces.

We have everything you need to bring your projects to life, no matter how creative you want to be!

Thierry Convert - Chairman





OUR ECO-COMMITMENT

Our commitment to socially responsible development is the cornerstone of everything we do, and guides all our investment, product innovation and management decisions.



Jouplast®

Made in France

“INNOVATION THAT RESPECTS PEOPLE AND THE ENVIRONMENT”

Environmental concerns

have, since 2008, progressively led to a convergence of opinion from many sources around the commitment of companies to **sustainable development**.

One of the main considerations is the need for a clear understanding of the rules for recycling. TMP CONVERT is careful to ensure that all the materials used in its JOUPLAST® products are **100% recycled**.

Accepting eco-responsibility requires us all to work together to guarantee a sustainable world for future generations.



2023
MORE
MOBILISED FOR RECYCLING

Our company has been awarded the MORE (MOBILISED for RECYCLING) accreditation

label by the French Plastics and Composites Federation certifying our use of 100% recycled textile industry plastics in manufacturing our products.

Our process produces no waste from defective components, which we recycle ourselves and feed back into the production cycle.



A photograph showing a row of cars parked on a grassy area. The cars are in various colors, including blue, red, and silver. The text is overlaid on a semi-transparent white box in the center of the image.

**Solutions for
paths, driveways
and parking spaces**

JOUPLAST® understands the importance of protecting nature against the damage that can be caused by impermeable surfacing materials like concrete and tarmac, and is proud to develop products that can be driven on to make access roads and parking spaces more natural and kinder to the environment. Whether in landscaped, urban, private or public settings, it is possible to consolidate ground used for this type of access without the need to use polluting materials.



IN LANDSCAPED AREAS

- Alveplac® • Gravels stabilisation p. 8
- Greenplac® • Grass consolidation p. 10

IN URBAN AREAS

- Urbangravel® • Gravels stabilisation p. 12

IN LANDSCAPED
AREAS



ALVEPLAC®

**GRAVEL STABILISATION MAT WITH GEOTEXTILE MEMBRANE
FOR LANDSCAPED AREAS**

The Alveplac® honeycombed mat provides a stable platform for gardens, paths and pedestrian areas. Suitable for private parking, gravel driveways, gardens... It includes a geotextile membrane, and can be joined on all four sides using a unique interlocking clip system.

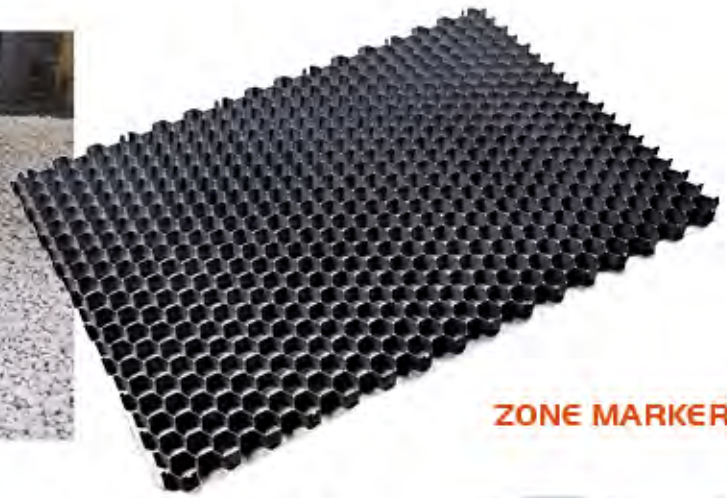

ZONE MARKER



PRODUCT FEATURES

- Geotextile membrane included (60 g/m²) and permanently bonded to the cells.
- Retains gravel.
- Ensures rapid drainage of rainwater.
- Prevents ruts.
- Can be installed on slopes up to 15% for pedestrian areas and 10% for vehicle use.
- Suitable even for heavy traffic.
- Integrated assembly system prevents mats from separating.
- Easily cut to shape.
- UV and frost resistant.

	SIMPLE - HEIGHT 30 mm	DOUBLE - HEIGHT 30 mm	ZONE MARKER
	Usable: 1150 x 790 x 30 mm Overall: 1166 x 800 x 30 mm	Usable: 1150 x 1580 x 30 mm Overall: 1166 x 1600 x 30 mm	
	Usable area: 0.91 m ² Cell Ø: 42 mm Cell shape: honeycomb Weight/m ² of 1 mat: 1.870 kg/m ²	Usable area: 1.82 m ² Cell Ø: 42 mm Cell shape: honeycomb Weight/m ² of 1 mat: 1.870 kg/m ²	Ø 44 mm (upper part) Ø 42 mm (lower part)
	Polypropylene		High-density polyethylene
	Grey or black Color might change depending on raw material supplying process.		White or grey
	650 T/m ² when filled		
	40 litres - 60 kg		
	Pallet of 38 part (grey) / stackable Ref. IHALV030GP40000 Pallet of 38 parts (grey) with integrated POS / stackable. Ref. IHALV030GP6000 Pallet of 38 parts (black) / stackable Ref. IHALV030GP70000	Pallet of 19 parts/ stackable Ref. IHALV030DP40000	Box of 100 parts White: Ref. IHBOUCALVBS10000 Grey: Ref. IHBOUCALVGS10000

DLP test report 01103426-P3



LAYING ALVEPLAC® ?

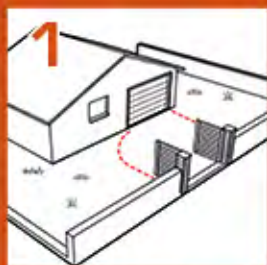

1 Mark out the area.



2 Prepare the ground.



3 Lay the geotextile membrane.



4 Lay the sub-base for pedestrian areas.



5 Lay the sub-base for traffic areas.

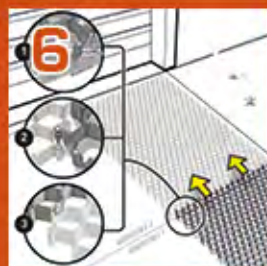

6 Lay the Alveplac® modules.



7 Fill and finish.



8 Cutting Alveplac® to shape.

INSTALLATION GUIDE



Video on joupplast.com

- To provide the stated load resistance, Alveplac® cells must be filled with gravel, plus an additional 2 cm top layer.
- Fill using 5-15 mm or 8-16 mm gravel.
- Gravel ranking should be necessary occasionally.

CREATE DRIVEWAYS, GARDENS AND PARKING SPACES

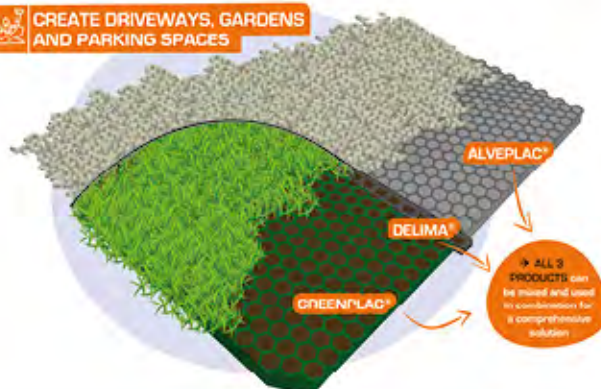

→ ALL 3 PRODUCTS can be mixed and used in combination for a comprehensive solution.

IN LANDSCAPED
AREAS



GREENPLAC®

GRASS STABILISATION TILE

Our GREENPLAC® honeycombed tile makes green spaces vehicle friendly by strengthening and protecting the grass without compromising drainage.

The cells structure is specially designed to allow dense and uniform lawn growth to completely cover the entire surface of the module.

Ideal for car parks, paths and access routes, as well as sports grounds, emergency or temporary roads, farming or equestrian areas and ground reinforcement.



ZONE MARKER



PRODUCT FEATURES

- Promotes strong root systems.
- Ensures rapid drainage of rainwater.
- Suitable for vehicle traffic.
- Can be installed on slope up to 15% for traffic areas.
- Can be used with Alveplac® and Delima®.
- Integrated anchoring and interlocking system.
- Slip resistant.
- UV and frost resistant.

	GREENPLAC®	ZONE MARKER
	Usable: 591 x 378 x 40 mm Overall: 600 x 390 x 40 mm	N/A
	Usable area: 0.223 m ² = 4.484 pads for 1 m ² Weight/m ² of 1 mat: 3.63 kg/m ² Cell Ø: 60 mm	Ø 63.5 mm
	Polyethylene	Polyethylene
	Green	White & grey
	Anchoring pins - qty: 4 / Length: 3 cm	N/A
	Pallet of 104 parts (stackable) = 23.192m ² /pallet. Tiles are assembled by 4. Ref. IGREENPLACV0000	Box of 40 parts White: Ref. IURBBOUCBL10000 Grey: Ref. IURBBOUCGR10000
	115 T/m ² with grass	N/A



LAYING GREENPLAC®

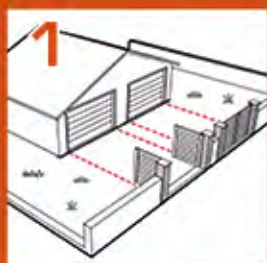

1 Mark out the area.



2 Prepare the ground.



3 Lay the geotextile membrane.



4 Lay the sub-base in accordance with the instructions.



5 Apply the surface layer.



6 Lay the Greenplac® tiles.



7 Seed with grass.

NB, please refer to instructions on our website regarding a farming or equestrian areas use.

INSTALLATION GUIDE



- For best results, choose a grass variety suited to your application.

WHEN LAYING ON A SLOPE



Cut off the 4 pins.



Insert them into the underside of the tile for extra grip.

URBANGRAVEL®

GRAVEL STABILISATION TILE WITHOUT GEOTEXTILE MEMBRANE FOR URBAN AREAS

Honeycombed tile without geotextile designed to consolidate and retain gravel for use in car parks, access roads, heavy traffic areas in industrial or commercial environments.



PRODUCT FEATURES

- Integrated assembly system prevents tiles from separating.
- Can be used for vehicles with axle loadings of up to 20 tonnes.
- UV and frost resistant.
- Prevents ruts and erosion.
- Can be installed on slopes up to 15% for traffic areas.
- Excellent natural rainwater drainage properties.
- Disabled access friendly.
- Stable in temperatures from -30°C to +60°C.
- No maintenance required.

URBANGRAVEL®		ZONE MARKER
Usable: 591 x 378 x 40 mm Overall: 600 x 390 x 40 mm		N/A
Wall thickness: 3 mm Usable area: 0.223 m ² soit 4.484 pads for 1 m ² Cell shape: honeycomb Cell Ø: 60 mm Integrated anchor pins: 4 pins - Length: 3 cm		Ø 63.5 mm
Polyethylene		Polyethylene
Grey		White & grey
Pallet of 104 parts (stackable) = 23.192m ² /pallet. Tiles are assembled by 4. Ref. IURBGRAVEL10000		Box of 40 parts White: Ref. IURBBOUCBL10000 Grey: Ref. IURBBOUCGR10000
Vertical resistance (empty): 112 T/m ² (i.e. 3 full lorries. Unfilled, Urbangravel® is suitable for use with 6/4, 6/6, 4/4 and 8/4 trucks and industrial vehicles).		N/A
Vertical resistance (filled): 600 T/m ² (i.e. 30 full lorries)		N/A
33 litres - 48 kg		N/A

ZONE MARKER





LAYING URBANGRAVEL®



1 Mark out the area.



2 Prepare the ground.

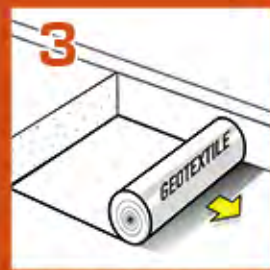

3 Lay the geotextile membrane.

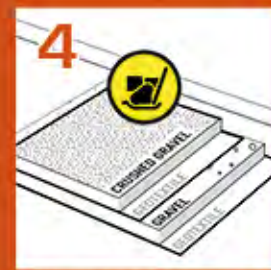

4 Lay the drainage and the upper sub-base.



5 Finishing base.



6 Lay the URBANGRAVEL® modules.

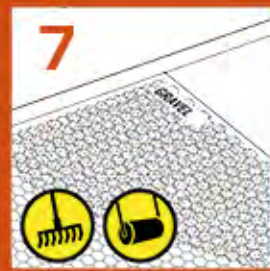

7 Fill and finish.

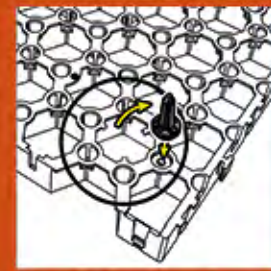

When laying on a slope, please cut and use the anchoring pins, and insert them into the underside of the tile for extra grip.

INSTALLATION GUIDE

- Fill the cells to the top using 8-16 mm gravel.



A vibrant garden scene featuring a central lawn area. To the left, there are large white hydrangea flowers and green foliage. In the foreground, there are plants with silvery-green, fuzzy leaves. The background is filled with dense green trees and shrubs, creating a sense of depth. A semi-transparent rectangular box is overlaid on the center of the image, containing the title text in orange. A thin orange horizontal line is positioned below the text.

SOLUTIONS FOR GARDEN LANDSCAPING

The JOUPLAST® range now extends beyond terraces and decking to span the full range of outdoor design options with garden landscaping products that allow you to create precisely the look you want without the need for major earthmoving and large-scale machinery. That's because our aim is always to respect the environment.



DEFINING LANDSCAPE SPACES

- DELIMA® border edging strip p. 16

CREATING GARDEN STEPS

- MODULESCA® garden steps p. 18

DELIMA®

FLEXIBLE BORDER EDGING STRIP







Heavy duty, flexible lawn edging makes it easy to create perfect straight lines or gentle curves between flowerbeds, lawn, gravel and paving. The lengths simply clip together and are secured in place using the 8 plastic anchor stakes. Strong enough to retain concrete or cold mixed asphalt.

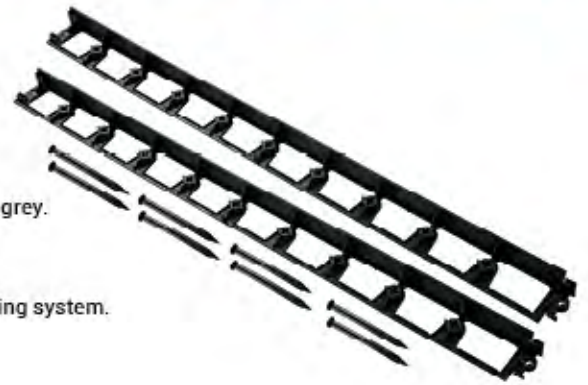

PRODUCT FEATURES

- Unique design for perfect straight lines and gentle curves.
- Blends seamlessly with the environment and available in 2 colours: green and grey.
- Use to form curves or straight lines.
- Invisible jointing system, and curvature resistance.
- Quick and easy installation with integrated anchoring, assembly and interlocking system.
- Safe: this flexible material can be used safely in playgrounds.
- 8 anchoring stakes provided.
- Easily transported pack lengths of 1.20 m.
- Easily cut to length.



DELIMA® BORDER EDGING STRIP		ANCHORING STAKE
	Usable: 235 (2 x 117.5 cm) x 8 x 4.5 cm Overall: 240 (2 x 120 cm) x 8 x 4.5 cm	Length: 20 cm
	Polyolefin 	Polystyrene 
	Anthracite grey / Green	Black
	Box of 50 parts of 2.40 m POS included / Ideal for self-service Green: Ref. IBORDU45B10000 Anthracite grey: Ref. IBORDU45B20000	Box of 90 parts Green: Ref. IBORDU45B30000 Anthracite grey: Ref. IBORDU45B40000
		By 8 / 8 stakes included



INSTALLING THE BORDER EDGING STRIP

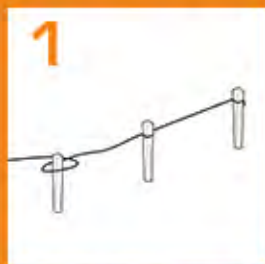

1 Mark out the shape.

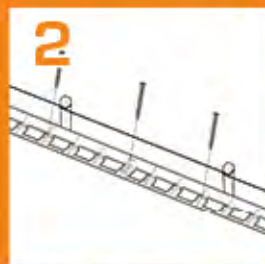

2 Position the border edging strip.

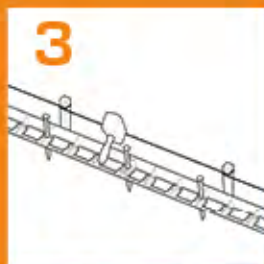

3 Fix the border edging strip in place.

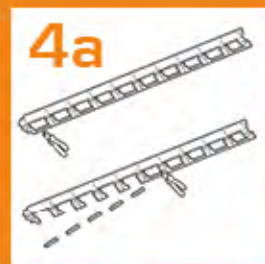

4a Cut to create a curve.



4b Create a curve.

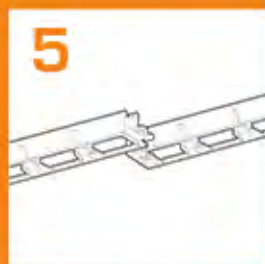

5 Link border edging strip sections together.

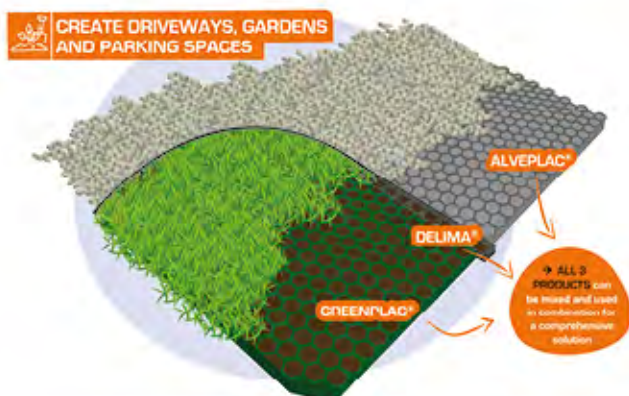

INSTALLATION GUIDE



- Do not use with hot mixed asphalt.
- When installing these edging strips in conjunction with Alveplac® and Greenplac®, which require the use of a vibrating compactor to compact the hardcore, we recommend the use of 250 x 8 mm metal stakes to avoid any possibility of vibration near the edging strip moving the plastic anchor stakes.
- Minimum radius for a 90° angle: 120 mm.

CREATING GARDEN STEPS



MODULESCA®

Patented System

THE MODULAR OUTDOOR STEP SYSTEM

The Modulesca® system uses interlinked modules to create straight or curved outdoor steps.

Once installed, the step modules can be clad in wooden, ceramic tiles or paving slabs. A set of steps can be easily created in half a day using only 2 tools: a screwdriver and a spirit level.



20 CM MODULE



CONNECTOR KIT

Pins and clips to attach steps or modules side by side.



93.4 CM STEP



JOIST KIT



PRODUCT FEATURES

- Quick to install: 1/2 day.
- Easy to install: only 2 tools required.
- Create steps with slope up to 70%.
- Your choice of finished cladding: wooden, ceramic tiles or paving slabs.
- Use 3 connector pins and clips to join 2 steps or modules together for wider steps.

	93.4 CM STEP	20 CM MODULE	CONNECTOR KIT LATÉRAL	JOIST KIT
	93.4 x 42.4 x 17 cm	42.4 x 20 x 17 cm	1 kit = 1 axis: 19 x 36 mm 1 fork: 26 x 31 mm	1 joist: 21 x 6 x 4 cm 2 joists: 35 x 6 x 4 cm
	Glass fibre reinforced polypropylene			Autoclaved pine - Class 4
	Per unit Ref. IM100NOP04 Pallet of 12 steps Ref. IM100NOP12	Per unit Ref. IM020NOP05	Box of 18 parts (for 6 assemblies) Ref. IMKITAFT18	Per unit Ref. IMKITBOI03
	41 litres	8.8 litres	N/A	N/A
	6 000 kg	6 000 kg	Shear strength: 750 daN	N/A



INSTALLING MODULESCA®



1 Prepare the site by digging out the slope and creating the location for the first step.



2 Put the first step in place, fill it with gravel or concrete, and continue building each new step on top of the previous step using the spacers and runners.



3a Wooden cladding: insert the joists in the slots provided and fix the deck boards to them.



3b Paving slab/ceramic tile cladding: fill the steps with aerated or standard concrete and bond the cladding in place using an appropriate adhesive.

SOME INSTALLATION SUGGESTIONS

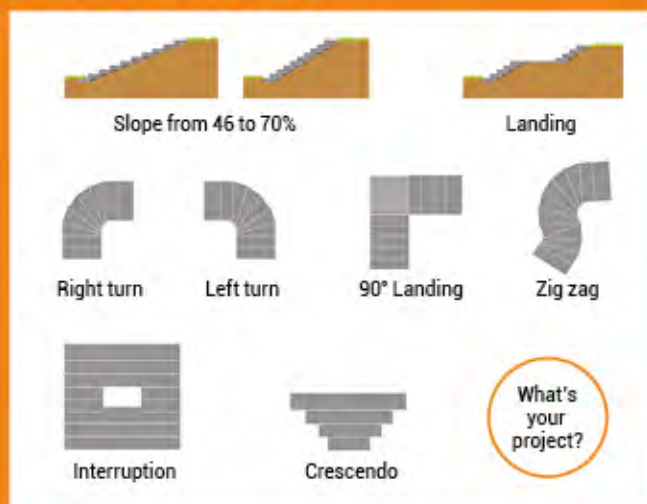

Use 3 pins and 3 clips in the positions provided to connect two modules/stairs side by side.

INSTALLATION GUIDE



- Modulesca® should only ever be installed on stabilised ground.
- Installation where there is no natural slope: Modulesca® can be installed on a frame (vertical legs, risers or inclined wooden or metal spar).

Please visit www.joupplast.com to use the Modulesca® configurator.



Solutions for terraces

JOUPLAST® has expanded its range considerably to cover all your paved terrace projects, especially those finished in ceramic tiles. We have responded to the emergence of increasingly large tile formats and tiles that mimic wood grain with a comprehensive choice of solutions that simplify installation for every kind of project.



THE BENEFITS OF JOUPLAST® PAVING RISER PEDESTALS	p. 22
«ESSENTIAL» RISER PEDESTALS	
• Standard risers.....	p. 24
• Self-levelling risers.....	p. 26
• Finishing products.....	p. 28
• Related products.....	p. 30
THE CLEMAN® RANGE	
• Standard/Self-levelling and the adjustment key.....	p. 32
• Related products.....	p. 34
DIRECT LAYING	
• Crossdalle® spacer.....	p. 36
• Slab spacers.....	p. 36
TERRACE CONSTRUCTION TOOLS	
• The slab grab.....	p. 37
• The paving lifter.....	p. 37
LAYING ON PROFILDECK®	
THE SELF-SUPPORTING TERRACE STRUCTURE	p. 38
COMPATIBILITY TABLE	p. 42

THE BENEFITS OF JOUPLAST® PAVING RISER PEDESTALS

THE COMPONENT PARTS OF A JOUPLAST® RISER PEDESTAL



The riser head
complete with 4 x 3 mm
snap-off spacers for greater
slab laying accuracy.
Bearing contact area: 100
cm².



208 mm diameter base
with chamfered edge to ensure a perfect
support. All sections have drainage holes
to prevent water retention (which can
stagnate and encourage mosquitoes).
Bearing contact area: 300 cm² for
excellent load distribution.



Rotating nut
with 8 lugs for easy super-accurate
adjustment.
The design ensures that the height
never varies, even under load.



Reinforcing ribs
for higher compressive strength.



Self-locking grooves
for greater stability.

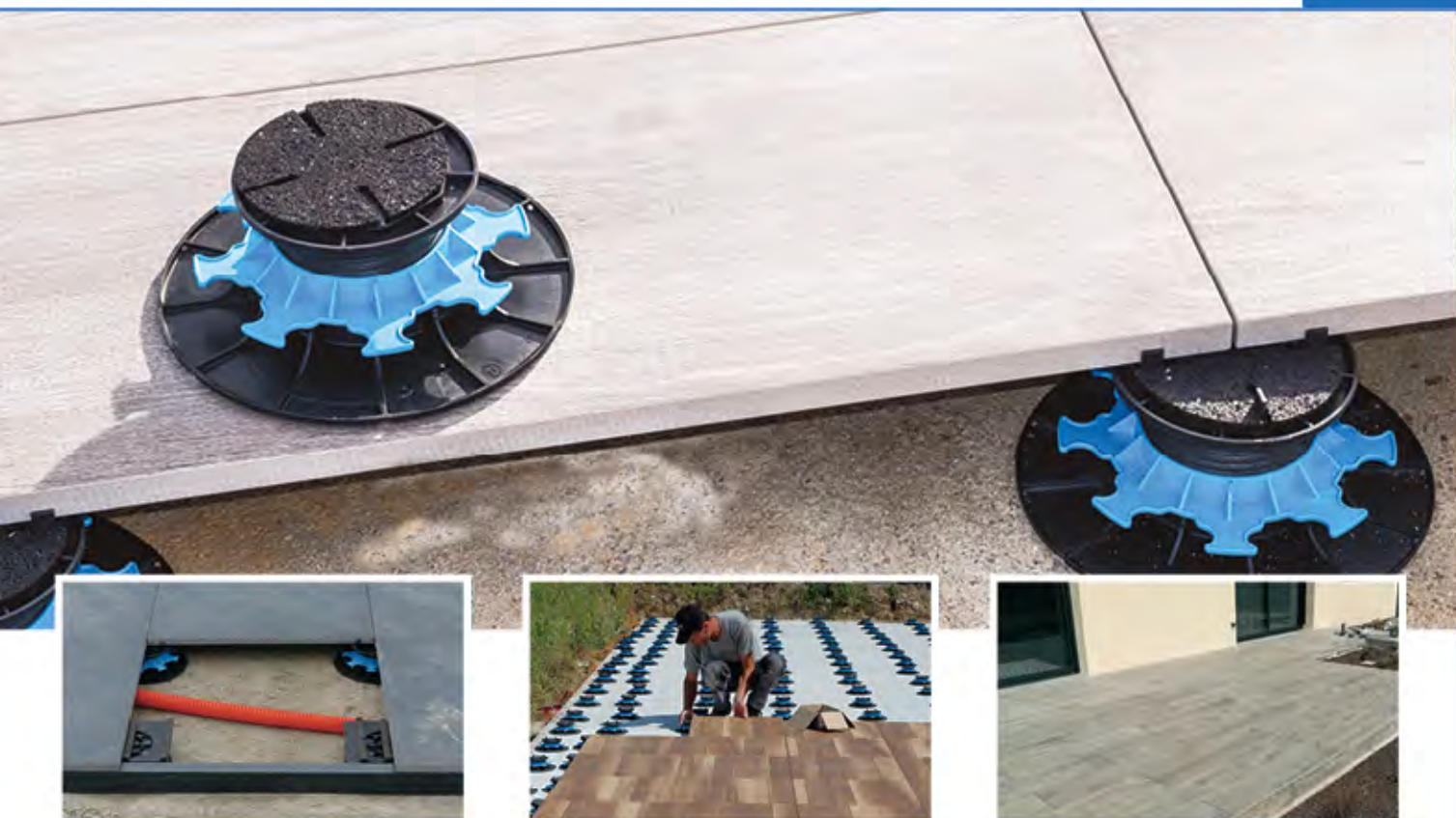

10 REASONS TO CHOOSE JOUPLAST® RISER PEDESTALS.

- Precise height adjustment using the rotating nut: no additional tools required.
- Quick and easy installation with simple site preparation with no need for heavy earthworks.
- Snap-off spacers for a shifted slab laying.
- Pipes and cables can be run beneath the terrace.
- Laying paving on riser pedestals avoids the need for mortar joints, allowing surface water to drain freely for maximum terrace.
- A wide range covering all heights from 8 to 470 mm.
- A comprehensive range of related products (see compatibility table).
- A unique solution to finish the perimeter.
- High resistance to crushing loads, UV and frost.

STANDARD RISERS

ADJUSTABLE AND FIXED HEIGHT SUPPORT FOR TERRACES
INSTALLED ON FLAT, LEVEL SURFACE.

Ideal for creating paved or ceramic tiled outdoor terraces for pedestrian use only.

Standard riser pedestals should be used only on stabilised ground levelled to a maximum height difference of 1.5%.



PLOGOM®

- 10 mm flexible support for dry installation of 20 mm ceramic slabs on concrete.
- The flexible material compensates for any irregularities to create a completely level surface.

From 8 to 470 mm



	HD 8/20 mm	PLOGOM®	HD 20/30 mm	HD 20/30 + HD 10
	From 8 to 20 mm	10 mm fix	From 20 to 30 mm	From 30 to 40 mm
	Ø 170 mm	Ø 120 mm Spacer thickness 3 mm	Ø 208 mm	
	Polypropylene	Thermoplastic elastomer	Polypropylene	
	Box of 3 bags of 20 parts Ref. IH008020DG20000	Box of 60 parts Ref. IH010FIXDC20000 Box of 5 bags of 10 parts Ref. IH010FIXDG20000	Box of 60 parts Ref. IH020030DC10000 Box of 5 bags of 12 parts Ref. IH020030DG30000	Box of 60 parts Ref. IH020030DC10000 + Ref. IH010FIXDC10000
Ideal for renovating decking / Divisible spacers for staggered laying				
	The smallest adjustable riser on the market	Rot-proof. Compensates for the roughness of the ground, and for 1-2 mm unevenness. Material preventing slipping		Raises from 30 to 40 mm with HD 10 mm extension
	See below.	To be placed directly on a concrete slab, a tiled terrace, lean screed...		See below.

Our risers can be used with the acoustic rubber cushion shown on page 31.



PLEASE REFER TO THE
COMPATIBILITY TABLE ON PAGE 42

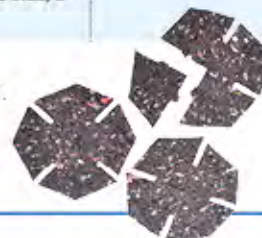



Video on
joupnet.com

INSTALLING RISER PEDESTALS

Paving riser pedestals should be used only on stabilised level ground or on existing concrete support.

1 PREPARE THE SURFACE.

On uneven ground:

- ➔ Remove about 15 cm of topsoil and level.
- ➔ Lay a geotextile membrane.
- ➔ Add hardcore and compact thoroughly.
- ➔ Measure the height between the prepared base level and the top of the finished surface to determine which version of riser pedestal you need.

On concrete support:

- ➔ Check the threshold clearance heights. Allow at least 3 cm for terraces clad in stone tiles.
- ➔ Measure the height between the prepared base level and the top of the finished surface to determine which version of riser pedestal you need.
- ➔ Check the levels to ensure good drainage.

2 PLACE THE RISERS ON THE GROUND, LAY THE SLABS ON THE RISERS, AND ADJUST THE HEIGHT OF THE PEDESTAL.

See page 66 to calculate the number of risers per m² and their positioning.

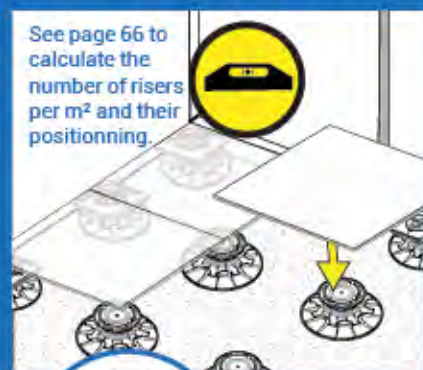

• Utilisation rehausse
110 GO, 110 25 ou 110
10 mm for 1 height
supérieure to 230 mm



HD 40/60 mm



HD 50/80 mm



HD 80/140 mm



HD 140/230 mm*

From 40 to 60 mm

From 50 to 80 mm

From 80 to 140 mm

From 140 to 230 mm and higher*

Base Ø 208 mm
Riser head Ø 120 mm

Polypropylene

Bag of 60 parts
Ref. IH040060DS10000

Box of 7 bags of 8 parts
Ref. IH040060DG30000

Bag of 60 parts
Ref. IH050080DS10000

Box of 6 bags of 8 parts
Ref. IH050080DG30000

Bag of 40 parts
Ref. IH080140DS10000

Box of 3 bags of 8 parts
Ref. IH080140DG30000

Bag of 40 parts
Ref. IH140230DS10000

Box of 2 bags of 6 parts
IH140230DG30000

Divisible spacers for staggered laying.

Precise height adjustment using the rotating nut no additional tools required.

See above.

INSTALLATION GUIDE

- The paving used must be self-supporting class T7, T11 or F+.
- At least one riser pedestal should be placed at each corner. Please refer to the tile manufacturer's recommendations to decide whether additional riser pedestals are required.



PLEASE REFER TO THE COMPATIBILITY TABLE ON PAGE 42

SELF-LEVELLING RISERS

HEIGHT-ADJUSTABLE SUPPORTS FOR CREATING TERRACES ON IRREGULAR AND UNEVEN GROUND

Fitted with a pivoting head, the self-levelling riser is designed to accommodate differences in the surface below the pedestal, automatically correcting differences in height of up to 5% and irregularities in compacted hardcore. The use of self-levelling risers is ideal for creating paved or ceramic tiled outdoor terraces for pedestrian use only.



PRODUCT FEATURES

- Self-levelling risers adapt to the irregularities of the ground.
- Can be used to create - or compensate for - slopes of up to 5% on uneven ground.

From 29
to 485 mm



*Use IIR 60 or IHD 10 mm extensions for heights above 230 mm.



	HA 29/39 mm	HA 55/75 mm	HA 65/95 mm	HA 95/155 mm	HA 155/245 mm*
	From 29 to 39 mm Raises from 39 to 49 mm with HD 10 mm extension.	From 55 to 75 mm	From 65 to 95 mm	From 95 to 155 mm	From 155 to 245 mm and higher*
	Base Ø: 208 mm Riser head Ø: 120 mm	Base Ø: 208 mm Riser head Ø: 120 mm	Base Ø: 208 mm Riser head Ø: 120 mm	Base Ø: 208 mm Riser head Ø: 120 mm	Base Ø: 208 mm Riser head Ø: 120 mm
	Polypropylene				
	Box of 60 parts Ref. IH029039DSN0000	Bag of 60 parts Ref. IH055075DSN0000	Bag of 60 parts Ref. IH065095DSN0000	Bag of 40 parts Ref. IH095155DSN0000	Bag of 40 parts Ref. IH155245DSN0000

Our risers can be used with the acoustic rubber cushion shown on page 31.

PLEASE REFER TO THE COMPATIBILITY TABLE ON PAGE 42

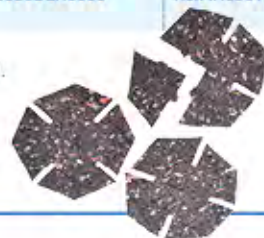



INSTALLING RISER PEDESTALS

Self-levelling riser pedestals should be used only on uneven ground or existing concrete support.

1 PREPARE THE SURFACE

On uneven ground:

- ➔ Remove about 15 cm of topsoil and level.
- ➔ Lay a geotextile membrane.
- ➔ Add hardcore and compact thoroughly.
- ➔ Measure the height between the prepared base level and the top of the finished surface to determine which version of riser pedestal you need.

On concrete support:

- ➔ Check the threshold clearance heights. Allow at least 5 cm for terraces clad in stone tiles.
- ➔ Measure the height between the prepared base level and the top of the finished surface to determine which version of riser pedestal you need.
- ➔ Check the levels to ensure good drainage.

- ### 2
- PLACE THE RISERS ON THE GROUND.
 - LAY THE SLABS ON THE RISERS.
 - ADJUST THE HEIGHT OF THE PEDESTAL.

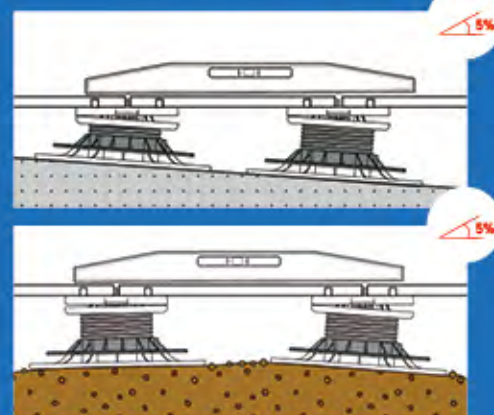

See page G6 to calculate the number of risers per m² and their positioning.

INSTALLATION GUIDE

- The paving used must be self-supporting class T7, T11 or F+.
- At least one riser pedestal should be placed at each corner. Please refer to the tile manufacturer's recommendations to decide whether additional riser pedestals are required.



Video on
jouplast.com



PLEASE REFER TO THE
COMPATIBILITY TABLE ON PAGE 42

TERRACE EDGES FINISHING WITH «ESSENTIAL» PAVING RISER PEDESTALS

100% INVISIBLE COMPLEMENTARY PRODUCTS
TO COVER THE TERRACE SIDES.

Makes it easy to finish the terrace neatly with no need for additional tools.
A 100% solution that uses an innovative glue trap system.



SIDE FINISHING PLATE

- Along the wall, it supports and stabilises the slab specially cut to size for attachment to the wall.
- Used on terrace edges and corners in combination with the lateral riser support, it provides vertical support for a plinth.



LATERAL RISER SUPPORT

- Creates a support for a plinth and aligns perfectly with the spaces between slabs.



	SIDE FINISHING PLATE	LATERAL RISER SUPPORT
	Dimensions: 206 x 206 mm	Dimensions: 100 x 67 x 28 mm
	Polypropylene	
	Box of 10 parts 75 boxes/stackable pallet Ref. IHPLADALDC10000	Box of 10 parts Ref. IHSUPHABIG10000 Box of 5 bags of 10 parts Ref. IHSUPHABIG10000
	100% invisible solution with a patented glue trap system.	100% invisible solution with a patented glue trap system. No plinth thickness limit.
	Raises the height of the riser by 13 mm. One lateral riser support per riser on the terrace periphery. To be placed on the riser head. Use the notches. Cannot be used with HD 8/20 and HD 20/30 mm. The acoustic rubber cushion cannot be used with the side finishing plate.	To be placed on the base. For a 100% invisible finishing, cut the little tab before the plinth gluing. For corner covering, provide 2 finishing supports. The tag can be conserved in case of a non-glued installation. It can be used to create a butress that will hold the plinth (a profile will be used to hold the upper part of the plinth). Provide a side finishing plate per periphery riser.

PLEASE REFER TO THE COMPATIBILITY TABLE ON PAGE 42

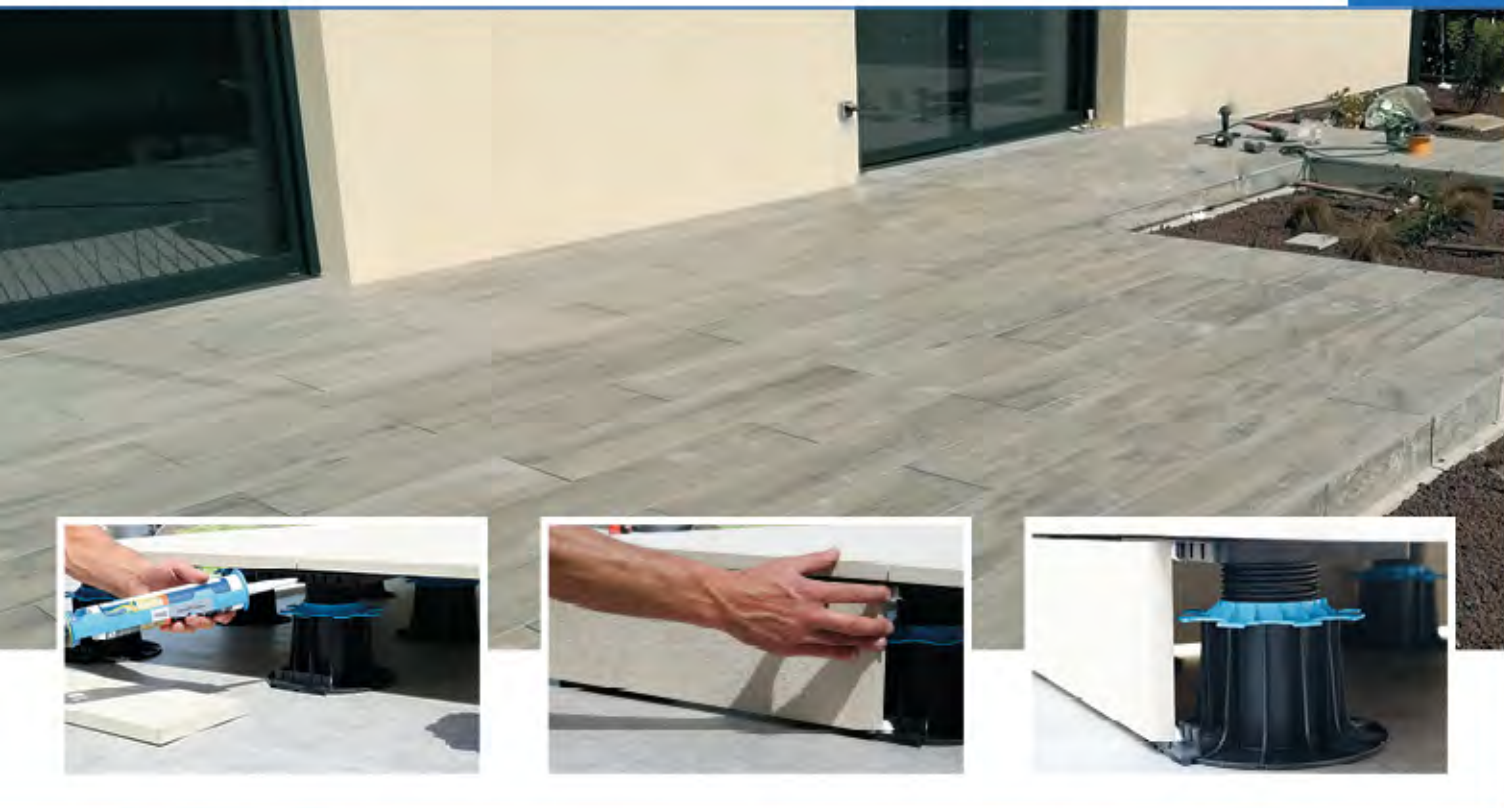

QUICK AND ACCURATE INSTALLATION WITH NO NEED FOR ADDITIONAL TOOLS

Side finishing plate + lateral riser support
= 3 possible configurations

Another configuration
option using only the lateral
riser support:



Invisible finish*



Plinth finish*

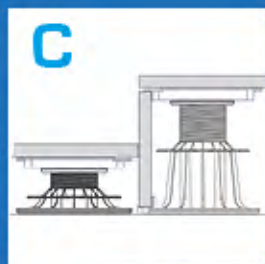

Creation of steps*

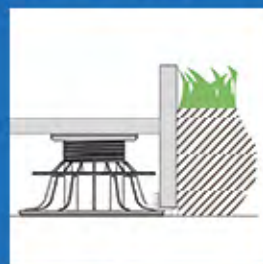

Buttress finish



Video on
joupplast.com

*An angle trim profile can be used, if preferred.



RELATED PRODUCTS FOR USE WITH PAVING RISER PEDESTALS

EXTENSIONS

Extensions increase the height of riser pedestals.
By combining different sizes, heights of up to
470 mm can be achieved.



HD 10 mm



HR 25 mm



HR 60 mm



	HD 10 mm	HR 25 mm	HR 60 mm
	Height: 10 mm	Height: 25 mm	Height: 60 mm
	Ø 120 mm	Ø 120 mm	Ø 120 mm
	Polypropylene		
	Box of 60 parts Ref. IH010FIXDC10000	Box of 120 parts Ref. IH025FIXRC10000	Bag of 60 parts / Ref. IH060FIXRS10000 Box of 5 bags of 8 parts Ref. IH060FIXRS30000
	Overlay up to 4 possible extensions. Divisible spacers.	Divisible spacers.	Overlay up to 4 possible extensions. Use the tags for an precise installation.
	To be positioned on the riser head.	To be positioned on the riser head. Only one extension possible, do not overlap. Used with risers of 40 mm minimum height.	To be placed between the base and the riser head. Not compatible with risers less than 50 mm high (See compatibility table on page 33).

PLEASE REFER TO THE
COMPATIBILITY TABLE ON PAGE 42



INSULATION MAT

Designed to isolate the pedestal base from the underlying sub-base.

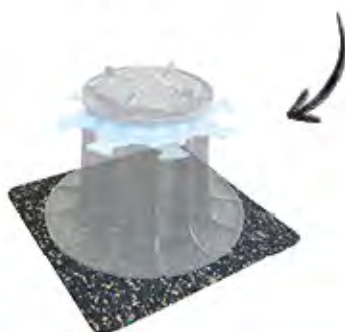

SLOPE CORRECTOR

Provides up to 2.5% slope correction.



ACOUSTIC RUBBER CUSHION

Significantly reduces any resonance and dampens vibration.

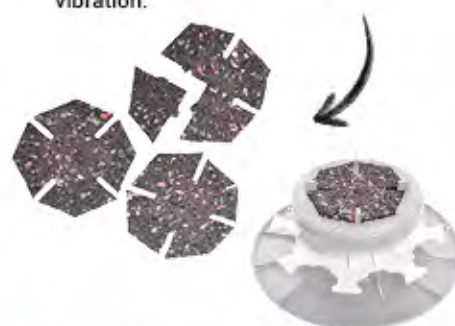

	INSULATION MAT	SLOPE CORRECTOR	ACOUSTIC RUBBER CUSHION
	Dimensions: 230 x 225 mm Thickness: 3 mm	Ø 213 mm	Ø 87.8 mm Thickness: 3 mm
	Recycled tyre	Polypropylene	Recycled tyre
	Box of 30 parts Ref. IHTAPISOL10000	Box of 40 parts Ref. IH025CORPC10000	Box of 100 parts Ref. IH003GOMDC10000 Box Pallet of 90 bags pluggable of 20 parts Ref. IH003GOMDC40000 Box of 10 bags of 20 parts Ref. IH003GOMDC30000
	Provides additional thickness, possible overlap. Reduces frame vibrations, impact noise and attenuates resonances. Distribution of weight by correcting foundation irregularities. Resistant, non-deformable and irremovable, the mat improves stability.	Overlay of up to 4 possible regulators, i.e. 10% of slope levelled.	Can be cut to compensate eventual thickness differences of slab. Solid. To be positioned on the riser head. Reduces noise and vibration by half (compared with using a riser pedestal alone).
	Do not use on gravel.	Install directly UNDER the riser without glue or screws. Adjust the positioning to the desired position thanks to the symbols on the plate.	To be positioned on the riser head.

CLEMAN® PAVING RISERS

ONE RISER, THREE APPLICATIONS

The CLEMAN® pedestal has 2 lateral riser supports integrated into its base and a glue trap system which avoids the need for additional tools to keep the perimeter plinth upright regardless of slab thickness. Use with the CLEMAN® Side finishing plate for great looking, professional finish without the need for angle trim.

- ➔ Installation preparation: pre-set using the driver bit.
- ➔ During installation: use the screw adjuster to set the riser pedestal height.
- ➔ On completion of installation: Adjust riser pedestal heights using the adjustment key.

PRODUCT FEATURES

- ➔ The ease and comfort of setting riser pedestal heights in advance, and making final adjustments using the adjustment key with the paving in place.
- ➔ Optimised stability: all the riser elements are mounted together.
- ➔ Lateral riser support system integrated.
- ➔ A square base makes it easy to lay paving at an angle.
- ➔ Rubber damper included.

* Utilisation CLEMAN® EXTENSIONS for height supérieure to 230 mm

Standard risers

From 28 mm to 470 mm



	DNC 28/40 mm	DNC 40/55 mm	DNC 55/80 mm	DNC 80/130 mm	DNC 130/230 mm*
	From 28 to 40 mm	From 40 to 55 mm	From 55 to 80 mm	From 80 to 130 mm	From 130 to 230 mm and higher*
	Dimensions of the base: 192 x 192 mm / Riser head Ø : 138 mm / Spacer thickness: 4 mm				
	Polypropylene				
	Box of 20 parts Ref. IH028040DNC0000	Box of 20 parts Ref. IH040055DNC0000	Box of 20 parts Ref. IH055080DNC0000	Box of 20 parts Ref. IH080130DNC0000	Box of 8 parts Ref. IH130230DNC0000

INSTALLING RISER PEDESTALS

1 PREPARE THE SURFACE

On uneven ground:

- ➔ Remove about 15 cm of topsoil and level.
- ➔ Lay a geotextile membrane.
- ➔ Add hardcore and compact thoroughly.
- ➔ Measure the height between the prepared base level and the top of the finished surface to determine which version of riser pedestal you need.

On concrete support:

- ➔ Check the threshold clearance heights. Allow at least 3 cm for terraces clad in stone tiles.
- ➔ Measure the height between the prepared base level and the top of the finished surface to determine which version of riser pedestal you need.
- ➔ Check the levels to ensure good drainage.

Paving riser pedestals should be used only on stabilised ground or on existing concrete slabs. Please check the ground for evenness and level before opting to use standard or selflevelling risers.



PRODUCT FEATURES

- The adjustment key allows to correct a level defect up to 1 mm (ie one quarter turn).

* Utilisation CLEMAN® EXTENSIONS for 1 height supérieure to 230 mm

Self-levelling risers From 40 mm to 470 mm



CLEMAN® ADJUSTMENT KEY

Finished height can be adjusted with the paving in place.

	ANC 40/55 mm	ANC 55/80 mm	ANC 80/130 mm	ANC 130/230 mm*	CLÉ CLEMAN®
	From 40 to 55 mm	From 55 to 80 mm	From 80 to 130 mm	From 130 to 230 mm and higher*	
	Dimensions of the base: 192 x 192 mm / Riser head Ø : 138 mm / Spacer thickness: 4 mm				Length: 274 mm Sleeve length: 166 mm
	Polypropylene				Steel
	Box of 20 parts Ref. IH040055ANC0000	Box of 20 parts Ref. IH055080ANC0000	Box of 20 parts Ref. IH080130ANC0000	Box of 8 parts Ref. IH130230ANC0000	Per unit Ref. IHCLEGLDNC0000
	Can be used to create - or compensate for - slopes of up to 5% on uneven ground.				Solid. Good grip.

2

- PLACE THE RISERS ON THE GROUND.
- LAY THE SLABS ON THE RISERS.
- ADJUST THE HEIGHT OF THE PEDESTAL.

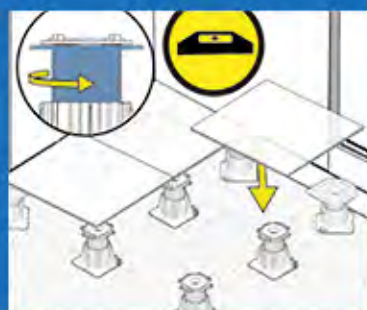

Voir p.67 for le nombre de plots au m² and leur positionnement.

USING THE ADJUSTMENT KEY

- Once the paving is in position, the CLEMAN® adjustment key can be used for any final height adjustments.
- Insert the key at the intersection of slabs, and adjust the height by turning to the left to raise the level, or to the right to lower it.
- The adjustment key allows to correct a level defect up to 1 mm (ie one quarter turn).
- NB: For large tiles format, or a specific laying, please see our instructions on our jouplast.com website.

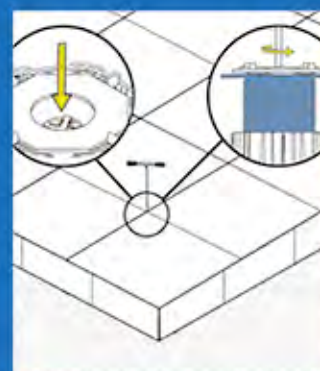

RELATED PRODUCTS



DRIVER BIT

Adjusts the height or pre-adjusts the risers using a screwdriver.



SIDE FINISHING PLATE

Finishes the terrace and makes installation easy at edges and against walls.



Patented System

CLEMAN® EXTENSIONS

Increase the height of standard and self-levelling risers.



	DRIVER BIT	SIDE FINISHING PLATE	60 MM EXTENSION
	Length: 105 mm Thickness: 4 mm	Dimensions: 218 x 218 mm	Height: 60 mm Ø 105.2 mm
	Hardened steel		Polypropylene
	Per unit Ref. IHMCLEDNC0000	Box of 10 parts Ref. IHPLDALCLEC0000	Box of 40 parts Ref. IHREHCLEDN0000
	The bit fits directly into the chuck of the screwdriver. The bit has a standard 10 mm hexagonal shape to fit on a 10 mm wrench, a 10 mm socket.	Specific shape, ideal for making 45° cut sections. Divisible 4 mm spacers are integrated. Can be used with small dimensions tiles: 20 cm. Can be used with standard and self-levelling CLEMAN® risers.	Optimised stability: extension to be screwed between the base and the nut. Up to 4 stackable risers.
	Pre-adjusts the CLEMAN® risers.	Raises the height of the riser by 10 mm. Adapt the plate position according to the installation. One side finishing plate per riser on the terrace periphery.	To screw on the riser basis.



PLEASE REFER TO THE
COMPATIBILITY TABLE ON PAGE 42

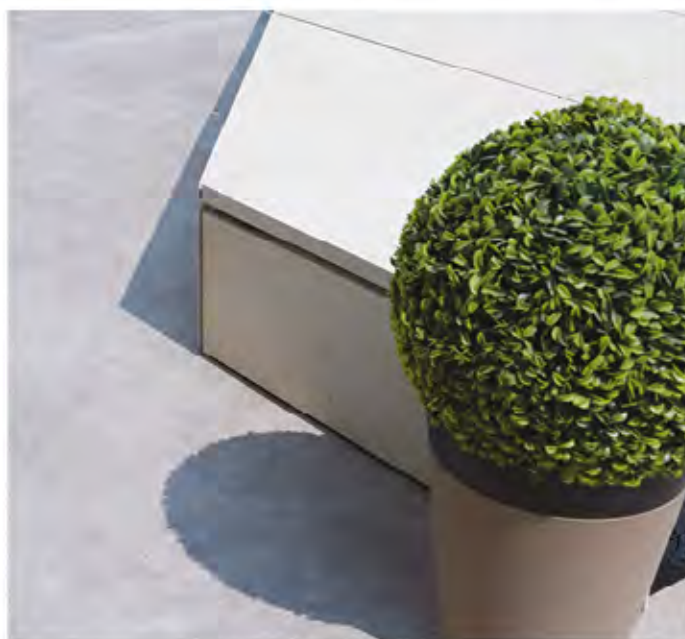

INSTALLATION GUIDE FOR SIDE FINISHING WITH CLEMAN® PRODUCTS

- ➔ Position the risers around the terrace perimeter, ensuring that the lateral riser supports are pointing outwards.
- ➔ For 45° cuts sections, position an intermediate riser at the corner to support paving joints.
- ➔ Position the side finishing plate on the riser head.
- ➔ Apply dots of PU glue to the dedicated channels on the finishing plate and to the lateral riser support.
- ➔ Lower the paving tiles onto the lateral riser support and press. Hold in place for a few seconds.
- ➔ Gently raise the plinth vertically so that the top engages with the PU glue previously applied to the side of the finishing plate.

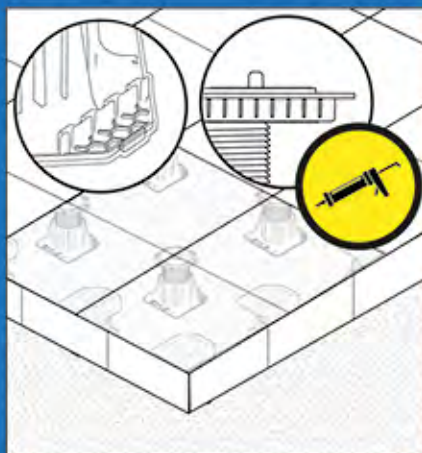

CROSS DALLE® AND SPACERS



CROSS DALLE®

Invisible stabilising brace for direct installation on sand or gravel.

The basis guarantees the good slabs evenness.



SPACERS

Spacers ensure a consistent gap between slabs during installation.



Video on jouplast.com

	CROSS DALLE®	SPACER 5 mm	SPACER 3 mm
	Stabilising spacer: 57 x 57 mm Spacer thickness: 3 mm Spacer height: 10 mm	Space between tiles: 5 mm Color: Black	Space between tiles: 3 mm Color: Blue
	Polypropylene	Polypropylene	
	Box of 5 bags of 48 parts Ref. IH003XDG10000	Box of 10 bags: 4 spacers 3 mm and 4 spacers 5 mm Ref. IHMIXECART10000	Box of 5 bags of 80 parts Ref. IH003EDGA0000 Box of 10 bags: 4 spacers 3 mm and 4 spacers 5 mm Ref. IHMIXECART10000
	Crossdalle is completely invisible, and does not impact the aesthetics of the installation. Divisible tabs and baseplate of the spacer to adapt to the types of installation. No water retention.	Combined, they are also used as braces. Spacers can be used on all ground.	
	Ideal for installing slabs directly on gravel or sand.	Insert the spacers regularly during installation. To be removed once tiles are installed.	

SLAB INSTALLATION



SLAB GRAB





Enables an individual slab to be easily lifted and replaced back into position.



PAVING LIFTER

Makes the pavement installation easier.
Enables to lift a slab for structure maintenance.



	SLAB GRAB	PAVING LIFTER
	Steel, plastic handle	Steel, PVC handle
	Per unit Ref. IHPOSDALDC10000	Box of 10 parts Ref. IHPOIGDALDC10000
	Good grip. Adjustable to adapt to several slab dimensions from 300 to 700 mm.	The handle helps in raising and lifting slab installed on riser pedestals. Easy access to the technical area under the the slabs (riser pedestals, electric cables, lights...) Robust product with a good grip. Helps in slab installation.
	Hold the handle tight when moving the slab. Handle carefully.	Lift with the handle and use your hand to take the grab the slab. Do not use to carry the slabs.

PROFILDECK® SELF-SUPPORTING TERRACE STRUCTURE

ALUMINIUM TWO-SIDED SUB-FRAME TO CREATE TERRACE OR WOODEN DECKING STRUCTURE

Profildeck® is a comprehensive patented terrace frame installation system.



PRODUCT FEATURES

- A single frame for 2 applications.
- Easy installation: only 4 tools (a miter saw, a measuring tape, a screwdriver and a level).
- Quick to install.
- The option to mix materials*.
- Perfect for installing large format slabs (120 x 120 cm) and narrow slabs (20 x 120 cm, 30 x 120 cm, etc.).
- Allows several installation possibilities: straight laying, staggered laying, multi-formats...
- Stability over time.
- Allows side finishing options.
- Offers the opportunity to connect and align different types of substrate: gravel/ concrete slab.
- Compatible with paving riser pedestals (we advice to use standard riser pedestals, but self-levelling ones can also be used), and decking riser pedestals («ESSENTIAL» and Elevo® range).
- For public or private use.

*Subject to maintaining the same cladding/paving thickness.



THE ESSENTIAL STRUCTURAL COMPONENTS

ALUMINIUM PROFILE

One side for installing terrace paving.
One side for installing wooden and composite decking.
2 different heights: H27 mm and H55 mm.



H27 **NEW**
Perfect for renovation
or for low projects.

PROFILDECK® SCREW

Secures brackets directly into the profile.



ADAPTER

Secures the Profildeck® profile to the «Essential» and «Elevo®» riser head and clips onto all Jouplast® riser heads (paving, inc. self-levelling and decking).



VERTICAL JUNCTION ANGLE BRACKET

For creating a second terrace level.



HORIZONTAL JUNCTION ANGLE BRACKET

For reinforcing 90° joints.



	PROFILE 27 MM	PROFILE 55 MM	ADAPTER	PROFILDECK® SCREW	VERTICAL JUNCTION ANGLE BRACKET	HORIZONTAL JUNCTION ANGLE BRACKET
	Dimensions: 3000 x 48 x 27.5 mm Height (Profile and adapter): 32.5 mm	Dimensions: 3000 x 49 x 55 mm Height (Profile and adapter): 60 mm	Dimensions: 158 x 82 x 48 mm	Dimensions: 4.8 x 19 mm Hexagonal head and integrated base	Dimensions: 75 x 75 mm Thickness: 2 mm	Dimensions: 50 mm x 54 mm Height: 30 mm Thickness: 2 mm
	100% recyclable aluminium		Polypropylene	Zinc plated steel		
	Packed by 4 parts Ref. IPDPRO3MC20000	Packed by 4 parts Ref. IPDPRO3MC10000	Box of 40 parts Ref. IPDADAPTAC10000	Box of 500 parts Ref. IPDVIFIEQC10000	Box of 8 bags of 20 parts Ref. IPDEQASVEC10000	Box of 6 bags de 20 parts Ref. IPDEQASHOC10000
	Double-sided: 1 product for 2 wooden or slab applications. For installing multi-format mineral slabs. Perfectly suited for installing large format slabs (120 x 120 cm) and installing thin width slabs (20 x 120 cm, 30 x 120 cm, etc.).		Can be used with all Essential risers from HD 20/30 mm, as well as with extensions RH 25.	Self-drilling.	Oblong holes for making adjustments.	
	Can be easily cut with a radial saw («multicut» type). NB: the H27 profile is to be used only with the 20/30 mm «Essential» riser pedestal (paving or decking riser).		Raises the height of the riser by 5 mm. Allows a perfect connection of the profile to the riser. Use the adapter to link 2 profiles together with the 4 fixing points.	Tightening torque 2.5 Nm max (for indication of reference "8" on an 18V cordless screwdriver).	Use 4 screws for each angle bracket. For an easier installation, place the bracket between the outer low rail of the profile.	



PLEASE REFER TO THE
COMPATIBILITY TABLE ON PAGE 43

PROFILDECK® SELF-SUPPORTING TERRACE STRUCTURE

PRODUCTS SPECIFIC TO PAVED TERRACES

EDGE FINISHING T-PIECE

Secures the vertical side paving to clad the upstands of PROFILDECK® terraces.



This component should be used in conjunction with the lateral riser support (see page 28).

SLAB SPACER

Creates a 3 mm drainage channel between paving elements.



RUBBER TAPE

Fixes the paving slabs to the profile, as well as reduces noise and resonance when walking on the terrace.



	EDGE FINISHING T-PIECE	SLAB SPACER	RUBBER TAPE
	Dimensions: 108 x 66.5 mm	Dimensions: 63 x 22.9 mm Tab thickness: 3 mm	Roll of 20 linear metres (2 x 10 m) Tape width: 12 mm Thickness: 3 mm Roll diameter: 22 cm
	Filled polypropylene	Polypropylene	Recycled tyre
	10 units per box Ref. IPDTEFIN1000	Box of 5 bags of 20 parts Ref. IPDCROISIC10000	Box of 10 x 2 rolls Ref. IPDBANGADC10000
	You will need only one single product to complete the lateral finishing of the terrace. Invisible vertical plinth support. Glue trap system.	10 mm side articulation. For offset installation. Divisible tabs.	Maintains the paving on the Profildeck® profile. Reduces noises and resonances. Resistance: UV and freezing.
	To be used with the PROFILDECK® structure screws.	To be clipped into the profile guide system.	To be positioned on the support rails of the slab side profile.

PLEASE REFER TO THE COMPATIBILITY TABLE ON PAGE 43



INSTALLING PROFILDECK®

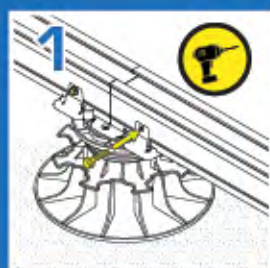

Position the adapter on the riser pedestal (NB: position a riser pedestal under every profile joint).

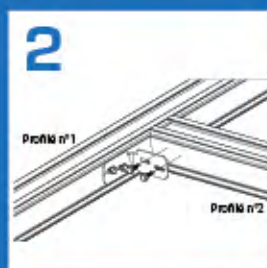

Join profile sections using horizontal junction angle bracket.

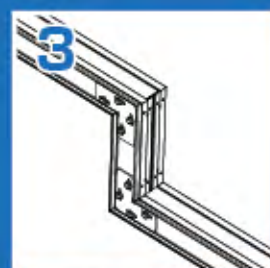

Join profile sections using vertical junction angle bracket to create a second level.

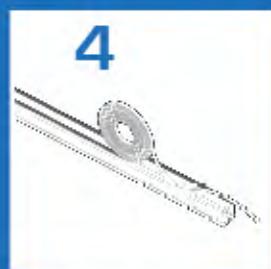

Apply the rubber tape.



Use the slab spacer.

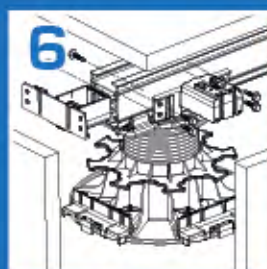

Corner of the terrace.

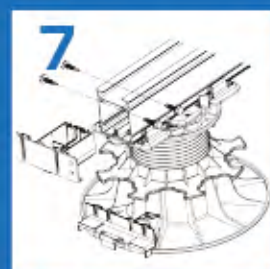

Profile extremity.

COMPATIBILITY TABLE

PRODUCTS COMPATIBILITY

“ESSENTIAL” RANGE RISERS

REFERENCES	STANDARD RISER							SELF-LEVELLING RISER				
	HD 10	HD 8/20	HD 20/30	HD 40/60	HD 50/80	HD 80/140	HD 140/230	HA 29/39	HA 55/75	HA 65/95	HA 95/155	HA 155/245
10 mm extension 4 max.	20/50 mm	✗	30/70 mm	50/100 mm	60/120 mm	90/180 mm	150/270 mm	39/79 mm	65/115 mm	75/125 mm	105/195 mm	165/285 mm
25 mm extension 1 max.	✗	✗	✗	65/85 mm	75/105 mm	105/165 mm	165/255 mm	✗	✗	✗	✗	✗
60 mm extension 4 max.	✗	✗	✗	✗	110/320 mm	140/380 mm	200/470 mm	✗	✗	125/395 mm	155/395 mm	215/485 mm
Side finishing plate 1 per riser Ø Mm of height	✗	✗	✗	53/73 mm	63/93 mm	93/153 mm	153/243 mm	✗	68/80 mm	70/108 mm	100/168 mm	160/250 mm
Lateral riser support 1 or 2 per riser	✗	✗	✗	To use with the side finishing plate.				✗	To use with the side finishing plate.			
Slope corrector 4 max.	✗	✗	✗	✓	✓	✓	✓	✓	✓	✓	✓	✓
Acoustic rubber cushion	⊗	⊗	⊗	⊗	⊗	⊗	⊗	⊗	⊗	⊗	⊗	⊗

All accessories are compatible with each other.

CLEMAN® RANGE

	DNC 28/40	DNC 40/55	DNC 55/80	DNC 80/130	DNC 130/230	ANC 40/55	ANC 55/80	ANC 80/130	ANC 130/230
Cleman® extensions 60 - 4 max.	✓	✓	✓	✓	✓	✓	✓	✓	✓
Acoustic rubber cushion Cleman®	+	+	+	+	+	+	+	+	+
Side finishing plate Cleman®	✗	✓	✓	✓	✓	✓	✓	✓	✓
Insulation mat	✓	✓	✓	✓	✓	✓	✓	✓	✓



COMPATIBILITY TABLE

PROFILDECK®

	PROFILDECK H55	PROFILDECK H27
Adapter	✓	✓
Horizontal junction angle bracket	✓	✗
Vertical junction angle bracket	✓	✗
Edge finishing T-piece	✓	✗
Spacer profildeck®	✓	✓
Anti-condensation strip	✓	✓
Rubber tape	✓	✓

PROFILDECK® VS. RANGES OF PEDESTALS

		PROFILDECK H55	PROFILDECK H27
Essential	Standard paving riser pedestal	✓ Except 8/20 mm	20/30 mm pedestal only
	Self levelling paving riser pedestal	✓	28/38 mm pedestal only
	PLOGOM®	✗	✗
	Extension HD 10 mm	✗	✗
	Extension HL 10 mm	✗	✗
	Extension HR 25 mm	✓	✓
	Decking riser pedestal	✓	20/30 mm pedestal only
	Rubber joist support	✗	✗
Elevo®	Decking riser pedestal	✓	✓
Cle man®	Standard paving riser pedestal	✗	✗
	Self levelling paving riser pedestal	✗	✗

✓ compatible
 ✗ incompatible
 X mm height adjustment
 + included
 ✗ not included



An aerial photograph of a backyard featuring a swimming pool with clear blue water. The pool is bordered by a light-colored concrete deck. Surrounding the pool is a wooden deck made of light-colored planks. Two lounge chairs are positioned on the wooden deck near the pool. In the foreground, a wooden deck is furnished with a grey wicker outdoor sofa and a matching ottoman, both with white cushions. The deck is set on a green lawn with some patches of grass. A semi-transparent white rectangular box is overlaid on the center of the image, containing the title text.

SOLUTIONS FOR WOODEN & COMPOSITE DECKING

Our wooden decking riser pedestals, standard or Elevo®, are simple to use, efficient and economical. The joists for the decking installation must never be laid directly on the support. To ensure decking ventilation, all joists must be laid on risers or wedges.



LAYING ON RISER PEDESTALS

- The benefits of JOUPLAST®
 - paving riser pedestals p. 46
 - «ESSENTIAL» riser pedestals p. 48
 - ELEVO® riser pedestal p. 51
 - Finishing products p. 52
 - Related products p. 53

LAYING ON PROFILDECK®

- THE SELF-SUPPORTING TERRACE STRUCTURE p. 54

HIGHLIGHT PRODUCTS FOR DECKING

- Secret screw fixings p. 56
- Decking protection p. 58
- Regular decking boards spacing p. 58

- COMPATIBILITY TABLE p. 59

- USING CONSTRUCTION WEDGES p. 60

THE BENEFITS OF JOUPLAST® PAVING RISER PEDESTALS

THE COMPONENT PARTS OF A JOUPLAST® RISER PEDESTAL



The riser head vertical base is used to secure the joist to the riser. Bearing contact area: 100 cm².



208 mm diameter base with chamfered edge to ensure a perfect support. All sections have drainage holes to prevent water retention (which can stagnate and encourage mosquitoes).



Rotating nut with 8 lugs for easy super-accurate adjustment. The design ensures that the height never varies, even under load.

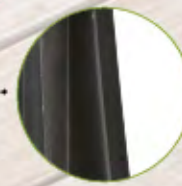

Reinforcing ribs for higher compressive strength.



Self-locking grooves for greater stability.



10 REASONS TO CHOOSE JOUPLAST® RISER PEDESTALS.

- Precise height adjustment using the rotating nut: no additional tools required.
- Quick and easy installation with simple site preparation with no need for heavy earthworks.
- Pipes and cables can be run beneath the terrace.
- A wide range covering all heights from 8 to 470 mm.
- A comprehensive range of related products (see compatibility table).
- When using riser pedestals, the subframe must be constructed using wooden or metal joists, and not composite joists.
- A unique solution to finish the perimeter.
- High resistance to crushing loads, UV and frost.
- Perfect design that ensures that the height never varies, even under load.
- Allows air to circulate and prevent excess damp.

«ESSENTIAL» RISER PEDESTALS

HEIGHT-ADJUSTABLE SUPPORTS FOR OUTDOOR DECKING FOR PEDESTRIAN USE

Ideal for natural wooden or composite decking for pedestrian use.

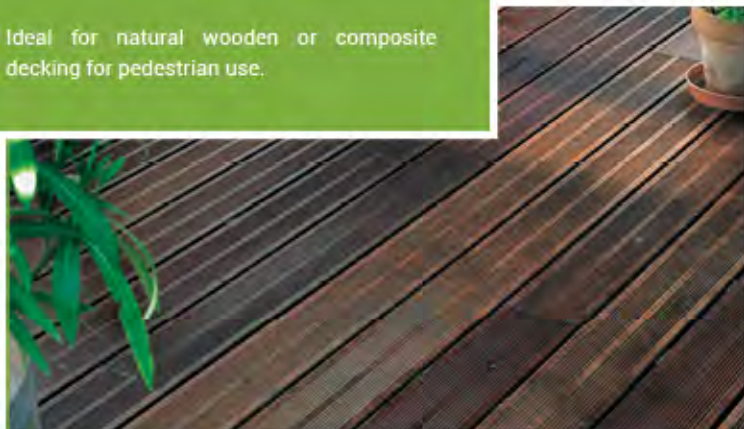

PRODUCT FEATURES

- Support base.
- Unlimited joist width.

From 8 to 470 mm



	RUBBER JOIST SUPPORT	HL 10 mm	HL 20/30 mm	HL 20/30 + HL 10	HL 40/60 mm
	Height: 8 mm	Height: 10 mm	From 20 to 30 mm	Raises from 30 to 40 mm with rehausse HL 10 mm.	From 40 to 60 mm
	Dimensions: 90 x 60 x 8 mm	∅ 120 mm	Base ∅ 208 mm / Riser head ∅ 120 mm		
	Recycled tyre	Polypropylene			
	48 units per pack Ref. IH008GOMLC20000	Box of 60 parts Ref. IH010FIXLC10000	Box of 60 parts Ref. IH020030LC10000 Box of 5 bags of 12 parts Ref. IH020030LG30000	Box of 60 parts Ref. IH020030LC10000 and Ref. IH010FIXLC10000	Bag of 60 parts Ref. IH040060LS10000 Box of 7 bags of 8 parts Ref. IH040060LG30000
	Reduces impact noise. Ventilation and insulation guaranteed. Rot-proof.	Can be used as a 10 mm extension.	Perfect for decking renovation.		
	To be used on flat and rigid ground. Stacking possible up to 4 wedges, i.e. 32 mm. Recommended distance between 2 wedges: 50 cm. Can be used with cover tape.	To be positioned on the riser head. 1 single extension per riser.	See below.		



INSTALLING RISER PEDESTALS

Decking riser pedestals should be used only on stabilised ground or on existing concrete support.

1 PREPARE THE SURFACE

On uneven ground:

- ➔ Remove about 15 cm of topsoil and level.
- ➔ Lay a geotextile membrane.
- ➔ Add hardcore and compact thoroughly.
- ➔ Measure the height between the prepared base level and the top of the finished surface to determine which version of riser pedestal you need.

On concrete support:

- ➔ Check the threshold clearance heights. Allow at least 8 cm for terraces clad in stone tiles.
- ➔ Use this measurement to determine which version of riser pedestal you need.
- ➔ Check the levels to ensure good drainage.

2 PLACE THE RISERS ON THE GROUND.

- POSITION THE JOISTS.
- FIX THE JOISTS IN PLACE.
- ADJUST THE HEIGHT.
- FIX THE DECKING BOARDS.

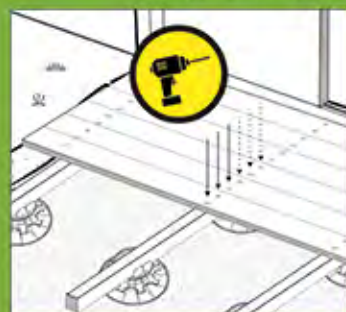
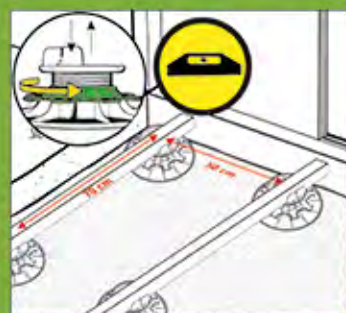

Please check the qty of riser per m² and their positioning on page 57



* Use 110 60 or 110 10 mm extensions for heights greater than 230 mm.

	HL 50/80 mm	HL 80/140 mm	HL 140/230 mm*
	From 50 to 80 mm	From 80 to 140 mm	From 140 to 230 mm and higher*
	Base Ø 208 mm / Riser head Ø 120 mm		
	Polypropylene		
	Bag of 60 parts Ref. IH050080LS10000 Box of 6 bags of 8 parts Ref. IH050080LG30000	Bag of 40 parts Ref. IH080140LS10000 Box of 3 bags of 8 parts Ref. IH080140LG30000	Bag of 40 parts Ref. IH140230LS10000 Box of 2 bags of 6 parts Ref. IH140230LG30000



INSTALLATION GUIDE



Video on joplust.com

- When using riser pedestals, the subframe must be constructed using wooden or metal joists, and not composite joists.
- Decking should be installed for outdoor pedestrian use only.



PLEASE REFER TO THE COMPATIBILITY TABLE ON PAGE 59



ELEVO[®], ADJUSTABLE RISER PEDESTAL FOR FENCE SUPPORT SPIKE

WOODEN OR COMPOSITE DECKING WITH NO GROUND PREPARATION

Ideal for installing wooden decking with minimal site preparation. The Elevo[®] decking riser head has a plastic box section base designed to locate on a metal fence post support (not supplied). 95 mm height adjustment range to set levels.



PRODUCT FEATURES

- Minimum site preparation required.
- Option to use «ESSENTIAL» 60 mm extensions to provide additional height.
- Can be used in conjunction with Profildeck[®] (see page 54).



43 mm to 138 mm adjustment from the top of the metal fence post support.



ELEVO [®]	
	From 43 to 138 mm
	Adjustment range: 95 mm Dimension: 90 x 90 mm Riser head Ø: 100 mm
	Polypropylene
	Box of 3 bags of 10 parts Ref. IHLVO140LG10000
	Position ELEVO [®] on top of the spike once it is set into the ground. Distance between risers is the same as the one use for "ESSENTIAL" riser pedestals.

EDGE FINISHING OF A WOODEN DECKING MADE WITH RISER PEDESTALS

100% INVISIBLE PRODUCT FOR FINISHING
TERRACE EDGES



INSTALLATION GUIDE



Finishing at end of joist

The lateral riser support enables the perimeter of the deck to be closed off.

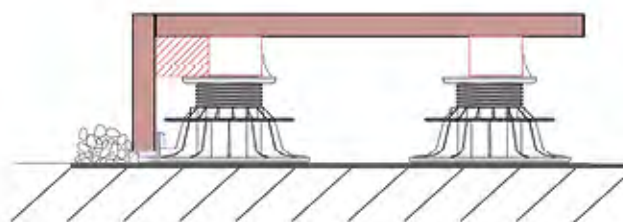

Finishing on the sides

To finish the sides of a decking terrace, add a batten to the joist secured to the riser head, and a short vertical joist to the lateral riser support.

LATERAL RISER SUPPORT

Provides a support for a vertical finishing board.

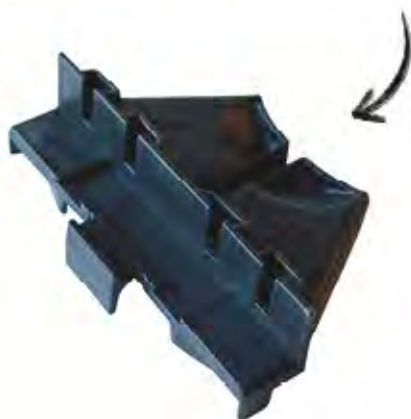

LATERAL RISER SUPPORT



100 x 67 x 28 mm



Polypropylene



Box of 10 parts

Ref. IHSUPHABIC10000

Box of 5 bags of 10 parts

Ref. IHSUPHABIG10000



Without additional tool.

Patented glue trap system.



To be placed on to the base.

You can remove the tag if necessary.

Use 2 supports per riser placed in corners.

RELATED PRODUCTS



EXTENSIONS

Increase the height of riser pedestals.
By combining different sizes, heights of up to 470 mm can be achieved.



HL 10 MM



HR 60 MM



SLOPE CORRECTOR

Positioned beneath the riser pedestal to compensate for slopes of 2.5%.

	HL 10 mm	HR 60 mm	SLOPE CORRECTOR
	Ø 120 mm Height: 10 mm	Ø 120 mm Height: 60 mm	Ø 213 mm
	Polypropylene		
	Box of 60 parts Ref. IH010FIXLC10000	Bag of 60 parts Ref. IH060FIXRS10000 Box of 5 bags of 8 parts Ref. IH060FIXRS30000	Box of 40 parts Ref. IH025CORPC10000
	Can be used as a 10 mm riser.	Overlay up to 4 possible extensions. Use the notches for an accurate installation.	Overlay of up to 4 possible regulators, i.e. 10% of slope levelled.
	To be positioned on the riser head. 1 single extension per riser.	To be placed between the base and the riser head. Not compatible with risers less than 50 mm high.	Install directly UNDER the riser without glue or screws. Position the regulator according to the desired direction.

PLEASE REFER TO THE COMPATIBILITY TABLE ON PAGE 59

PROFILDECK® SELF-SUPPORTING TERRACE STRUCTURE

DOUBLE-SIDED ALUMINIUM PROFILE FOR CONSTRUCTION OF WOODEN DECKING AND PAVED TERRACES



PRODUCT FEATURES

- A single frame for 2 applications.
- Easy installation: only 4 tools (a miter saw, a measuring tape, a screwdriver and a level).
- Quick to install.
- The option to mix materials*
- Stability over time.
- Allows side finishing options.
- Offers the opportunity to connect and align different types of substrate: gravel/ concrete slab.
- Lighter than a wooden structure.
- Compatible with paving riser pedestals (we advice to use standard riser pedestals, but self-levelling ones can also be used), and decking riser pedestals («ESSENTIAL» and Elevo® range).
- For public or private use.

*Subject to maintaining the same cladding/paving thickness.

	PROFILE H27	PROFILE H55	ADAPTER	PROFILDECK® SCREW
	Dimensions: 3000 x 48 x 27.5 mm Height (Profile and adapter): 32.5 mm	Dimensions: 3000 x 49 x 55 mm (1.06 kg / linear metres) Height (Profile and adapter): 60 mm	Dimensions: 158 x 82 x 48 mm	Dimensions: 4.8 x 19 mm Hexagonal head and integrated base
	100% recyclable aluminium		Polypropylene	Zinc plated steel
	Packed by 4 parts Ref. IPDPRO3MC20000	Packed by 4 parts Ref. IPDPRO3MC10000	Box of 40 parts Ref. IPDADAPTAC10000	Box of 500 parts Ref. IPDVIREQC10000
	Double-sided: 1 product for 2 wooden or slab applications.		Raises the height of the riser by 5 mm.	Self-drilling. Tightening torque 2.5 Nm max (for indication of reference "8" on an 18V cordless screwdriver).
	Can be easily cut with a radial saw («multicut» type). NB: the H27 profile is to be used only with the 20/30 mm «Essential» riser pedestal (paving or decking riser).		Allows a perfect unity of the profile to the riser. Use the adapter to link 2 profiles together with the 4 fixing points. Can be used with risers from 20/30 mm minimum height.	

THE ESSENTIALS FOR BUILDING A WOODEN OR COMPOSITE DECK WITH PROFILDECK®

ALUMINIUM PROFILE

One side for installing wooden and composite decking.

One side for installing terrace paving.

2 different heights: H27 mm and H55 mm.

H27 **NEW**

Perfect for renovation or for low projects.



ADAPTER

Secures the Profildeck® profile to the «ESSENTIAL» and «Elevo» riser head and clips onto all Jouplast® riser heads (paving, inc. self-levelling and decking).

Ensures good lateral stability of the profile to the riser, and excellent shearing resistance.



PROFILDECK® SCREW

Secures brackets directly into the Profile.



VERTICAL JUNCTION ANGLE BRACKET

For creating a second terrace level.



HORIZONTAL JUNCTION ANGLE BRACKET

For reinforcing 90° joints.



ANTI-CONDENSATION TAPE

Prevents increased Profildeck® profile and terrace moisture content.



DECKING BOARD SCREW

For fixing wooden decking boards to the profile.



LAYING PROFILDECK® ?



Position the adapter on the riser pedestal (NB: position a riser pedestal under every profile joint).

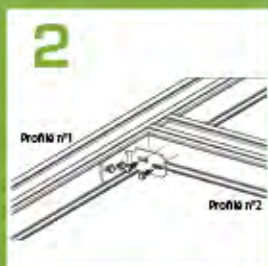

Join profile sections using horizontal junction angle bracket.



Join profile sections using vertical junction angle bracket to create a second level.



Lay the anti-condensation tape.



Video on jouplast.com

	VERTICAL JUNCTION ANGLE BRACKET	HORIZONTAL JUNCTION ANGLE BRACKET	ANTI-CONDENSATION TAPE	DECKING BOARD SCREW
	Dimensions: 75 x 75 mm Thickness: 2 mm	Dimensions: 60 x 32 mm Thickness: 2 mm	Roll of 20 linear metres Tape width: 50 mm Roll diameter: 19 cm	Dimensions: 5.5 x 45 mm Countersunk head screw with wings End cap: SIT20
	Zinc plated steel		Polyethylene foam	Zinc plated steel
	Box of 8 bags of 20 parts Ref. IPDEQASVEC10000	Box of 6 bags of 20 parts Ref. IPDEQASHOC10000	Box of 18 rolls Ref. IPDBANPROC10000	Box of 50 units Ref. IPDVISLAMCT10000
	Oblong holes for making adjustments.		Self-adhesive. Tear-proof.	Self-drilling.
	Use 4 screws for each angle bracket. For an easier installation, locate the bracket between the outer low rail of the profile.		To affix on a clean and dry support.	Tightening torque 7 Nm max (for indication "18" on 18V cordless screwdriver).

PLEASE REFER TO THE COMPATIBILITY TABLE ON PAGE 59

SECRET SCREW FIXINGS

FIXEGO® INVISIBLE FIXING FOR WOODEN DECKING BOARDS

Fixego® is the Jouplast® system for secret fixing of wooden decking. This innovative and versatile product enables quick and easy decking installation with no unsightly screw holes.



PRODUCT FEATURES

- 100% invisible.
- Extends decking life by providing effective ventilation.
- Perfect for individual decking board replacement.
- Ideal for renovating decking.
- Good pullout test.
- Screw fixings: Treated with SILVERPLUS and Lubex for easy fixing and high corrosion resistance.



	FIXEGO® FOR BOARDS THICKNESS 19-25 mm	FIXEGO® FOR BOARDS THICKNESS 25mm	START AND END CLEAT
	Dimensions: 203 x 20 x 10 mm		Dimensions: 26.5 x 38 x 10 mm
	Reinforced polypropylene		
	Good pull out resistance. Conforms to French regulation DTU 51.4.		
	By bucket = 4 m ² 1 bucket = 64 Fixings + 200 screws 6 x 25 + 20 Cleats + 24 screws 4 x 25 + 4 spacers <i>Ref. IH021FLTLG10000</i>	By bucket = 4 m ² 1 bucket = 64 Fixings + 200 screws 6 x 30 + 20 Cleats + 24 screws 4 x 25 + 4 spacers <i>Ref. IH028FLTLG10000</i>	Box of 10 Cleats and 24 screws (4x25) <i>Ref. IH020TAQXC10000</i>
	One single reference for all installation steps (Start, processing, finishing and renovation).		One single part for the start and the end of the joist. The cleat can be used as a 5 mm template to ensure its good positioning.
	Please see below. Directions for use available on our website.		



USING THE FIXEGO® SYSTEM



1
Build the decking subframe.



2
Prepare the components.



3
Begin laying the decking.

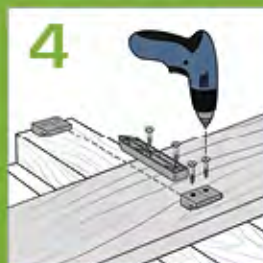

4
Prepare the first decking board.

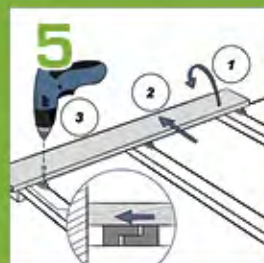

5
Turn and secure the board.

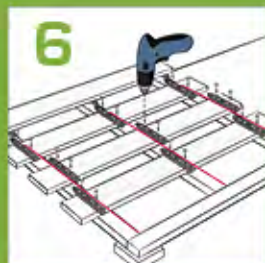

6
Prepare the remaining decking boards.



7
Turn, slide and fix each decking board.



8
Prepare the final decking board.

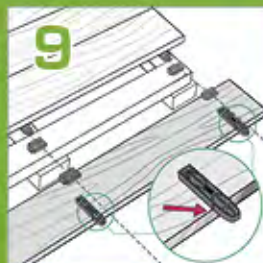

9
Attach the final components.



10
Fix the final decking board.

NUMBER OF CLEATS

IFA =	1 m	2 m	3 m	4 m	5 m
CLEATS	12	20	28	36	44

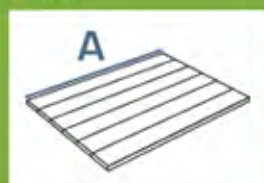

INSTALLATION GUIDE



- Do not use Fixego® with composite boards.
- Wooden decking boards must have a moisture content of between 18 and 22% to avoid any risk of the structure becoming unstable. The structural integrity of FIXEGO® installations is not guaranteed where decking board moisture content is above 22%.
- It is recommended that the joists and the decking boards are made from the same species of wood.
- Fixego® is not recommended for use with unstable wood, such as acacia.



DECKING PROTECTION

DECKING COVER TAPE



DECKING COVER TAPE	
	Roll of 20 linear metres Length: 77 mm
	Polyethylene foam
	Box of 18 rolls Ref. IH080BDPLC100000
	Extends the terrace lifetime. Adheres to wood, metal. Seals the frame. Resistance to tearing, atmospheric agents and UV.
	To place on a clean and dry support. To be placed on to the decking joists.

REGULAR DECKING BOARDS SPACING

SPACERS

Spacers ensure a consistent gap between slabs or decking boards during installation.



	SPACER 5 mm	SPACER 3 mm
	Space between wooden boards: 5 mm Color: Black	Space between wooden boards: 3 mm Color: blue
	Polypropylene	
	Box of 10 bags: 4 spacers 3 mm and 4 spacers 5 mm Ref. IHMIXECART10000	Box of 5 bags of 80 parts Ref. IH003EDGA0000 Box of 10 bags: 4 spacers 3 mm and 4 spacers 5 mm Ref. IHMIXECART10000
	When combined, they are also used as braces. Regular distance between the boards. Can also be used with composite decking boards.	
	Insert the spacers regularly during installation. To be removed once tiles are installed.	

COMPATIBILITY TABLE

PRODUCT COMPATIBILITY

DECKING RISER PEDESTALS

REFERENCES	ESSENTIAL STANDARD RISER						PLOT ELEVO® 95 MM
	HL 10	HL 20/30	HL 40/60	HL 50/80	HL 80/140	HL 140/230	ELEVO®
10 mm extension (1 max.)	✗	30/40 mm	50/70 mm	60/90 mm	90/150 mm	150/240 mm	105 mm
60 mm extension (4 max.)	✗	✗	✗	110/320 mm	140/380 mm	200/470 mm	155/305 mm
Slope corrector (4 max.)	✗	✗	✓	✓	✓	✓	✗
Lateral riser support. (1 or 2 per riser)	✗	✗	✓	✓	✓	✓	✗

PROFILDECK®

	PROFILDECK H55	PROFILDECK H27
Adapler	✓	✓
Horizontal junction angle bracket	✓	✗
Vertical junction angle bracket	✓	✗
T of finition	✓	✗
Spacer Profildeck®	✓	✓
Anti-condensation strip	✓	✓
Rubber tape	✓	✓

PROFILDECK® VS. RANGES OF PEDESTALS

		PROFILDECK H55	PROFILDECK H27
Essential	Standard paving riser pedestal	✓ Except 8/20 mm	20/30 mm pedestal only
	Self levelling paving riser pedestal	✓	28/38 mm pedestal only
	PLOGOM®	✗	✗
	Extension HD 10 mm	✗	✗
	Extension HL 10 mm	✗	✗
	Extension HR 25 mm	✓	✓
	Decking riser pedestal	✓	20/30 mm pedestal only
	Rubber joist support	✗	✗
Elevo®	Decking riser pedestal	✓	✓
Cleman®	Standard paving riser pedestal	✗	✗
	Self levelling paving riser pedestal	✗	✗

✓ compatible

✗ incompatible

X mm height adjustment



USING CONSTRUCTION WEDGES

**USED FOR ALL CARPENTRY WORKS:
DECKING, WOODEN FLOORING, WINDOWS...**

Our wedges can be used for all interior and exterior carpentry work and for packing wooden floors including decking and parquet.

Simple adjustments from 2 to 40 mm:

- ➔ Plastic shims allow adjustments from 2 mm.
- ➔ Ridged wedges height 90 mm: allow adjustments from 14 to 20 mm.
- ➔ Ridged wedges height 170 mm: allow adjustments from 11 to 40 mm.



DIVISIBLE PLASTIC SHIMS

The only shim on the market that can be snapped into 2 or 4 sections.



90 MM RIDGED WEDGES

From 14 to 20 mm.



The use of shims or wedges provides a good ventilation of the decking structure.

DIVISIBLE PLASTIC SHIMS

90 MM RIDGED WEDGES mm



3 references 80 x 60 mm
1 colour per thickness
● 2 mm - green ● 3 mm - Blue ● 5 mm - Black

Dimensions: 94 x 46 x 12 mm
Adjustment range from 14 to 20 mm



Polypropylene



Box of 12 mixed bags of 3 x 25 parts (pluggable)
Ref. IHMIX025CG10000
Mixed bucket of 3 x 100 parts Ref. IHMIX100CB10000
Box of 10 bags of 40 parts
● Ref. IH002CRGA0000 ● Ref. IH003CRGA0000 ● IH005CRGA0000

Bucket of 100 parts Ref. IH090CALEB10000
Mixed bucket H90 x 50 + H170 x 30 Ref. IHMIXCALEB10000
Box of 8 bags of 30 parts Ref. IH090CALEG10000



Can be stacked due to the lugs.
Compatible with ridged wedges.
Packaging in practical buckets for construction sites.

Adjustment from 14 to 20 mm.
Saw teeth provide precise wedging.
Compatible with flat shims.
Packaging in practical buckets for construction sites.



Can be screwed, glued or nailed.



170 MM RIDGED WEDGES

From 11 to 40 mm in a single product.



FORK SHIMS

For packing from 1 mm upwards.

Ideal for packing out joinery, as well as cladding, panelling, door frames and flooring.



	170 MM RIDGED WEDGES	FORK SHIMS
	Dimensions: 172 x 46 x 12 mm Adjustment range from 11 to 40 mm	4 references / 1 colour per thickness 1 mm - White ● 2 mm - Green ● 3 mm - Blue ● 5 mm - Black Dimensions: 44 x 44 mm
	Polypropylene	
	Bucket of 50 parts <i>Ref. IH170CALEB10000</i> Mixed bucket H90 x 50 + H170 x 30 <i>Ref. IHMIXCALEB10000</i> Box of 12 bags of 25 parts (pluggable) <i>Ref. IH170CALEG10000</i>	Mixed bucket of 4 x 100 cales <i>Ref. IHMIXCALFOU10000</i>
	Saw teeth provide precise wedging location. Compatible with flat shims. Packaging in practical buckets for construction sites.	Fork shape with flexible inner comb to clip the shim (s) onto a screw. Can be stacked due to the lugs. Removable tab. Packaging in practical buckets for construction sites.
	Can be screwed, glued or nailed.	

PRODUCT ENVIRONMENT INFORMATION

FOR CONSTRUCTION OF PAVED TERRACES

- The paving used must be self-supporting.
- Follow the paving manufacturer's installation recommendations, and calculate the number of riser pedestals per m² for your application.

FRENCH CERAMIC/PORCELAIN PAVING CLASSIFICATION:

- T7 for private terraces, where riser pedestal height is ≤ 0.15 m.
- T11 for shared or public terraces, and for private terraces where the riser pedestal height is > 0.15 m.
- F+ for ceramic tile surfaces laid on riser pedestals.

GENERAL LAYOUT RULES*

Direction of laying

In terms of appearance, it is better to ensure that cut paving is adjacent to the wall (full paving tiles away from walls).



*GLOSSARY

LAYOUT PLAN

Drawing up a layout plan can be very helpful, because it allows you to see how the various elements of the project work together and interact.

For example, it will clearly show how the tile layout looks in terms of colour and orientation, as well as the quantities of each component required.

SLENDERNESS

The ratio between paving thickness and width.

CENTRE-TO-CENTRE DISTANCE

The centre-to-centre distance is the distance between the centrelines of components within an assembly, or between assemblies (e.g. the centre-to-centre distance between joists).

BRACE

A length of wooden inserted between joists to strengthen the frame.

EXTERIOR WOODEN DECKING

Exterior floor surface consisting of decking boards secured to joists fixed to sub-frames sitting on stabilised foundations (riser pedestals, wedges beams, etc.).

WHEN LAYING WOODEN DECKING

- Decking boards should never be laid directly on the ground, but on joists separated from the ground using wedges or pedestals (centre-to-centre distance* 50 cm maximum).
- On natural terrain, the structure must be constructed on previously prepared ground. We strongly recommend the use of a geotextile membrane.
- Apply protection tape between the joist and decking boards.
- Decking boards must be fixed in place using countersunk stainless steel screws (minimum A2 grade).
- Pre-drilling is highly recommended.

⚠ CAUTION The subframes of terraces supported using riser pedestals must be constructed using wooden or aluminium joists, NOT COMPOSITE JOISTS.

GENERAL RULES FOR CONSTRUCTING WOODEN SUBFRAMES

Always leave a gap between the wooden and the ground surface.

External wooden cladding planks* must be raised off the ground to ensure proper ventilation of the structure.

Use polymer packers or risers to elevate the frame off the ground. Construct a cross-braced wooden frame whenever possible.

Fitting braces* between the joists strengthens the structure and gives it greater stability.

Direction of installation

Before starting work, it is important to prepare an installation or layout plan, which should include:

- Cutting lists and plans.
- A decking board laying plan with/without centre-to-centre distances between decking boards.
- The direction in which the decking boards will be laid

For reasons of appearance and safety, decking boards should be laid parallel to the wall that contains the doorway providing access to the terrace.

Choose your decking boards carefully.

Decking board quality

Buying poor quality decking boards can compromise the finished project. Reject twisted or damaged decking boards and those with irregular grain.

Decking board moisture content

Ensure that the decking boards you choose have been dried in accordance with the specification applying to that type of wooden.

AD: The Air Drying technique is used for naturally stable wooden (e.g. IPE hardwood decking).

KD: The Kiln Drying technique is used for wooden that requires a more carefully controlled drying environment.

Wooden decking boards must have a moisture content of between 18 and 22% to avoid any risk of the structure becoming unstable.

⚠ CAUTION Always check with your wooden supplier.



Wooden decking maintenance

Over time, decking boards may become slightly grey.

This is a natural effect caused by the oxidation of a thin surface layer when exposed to UV from natural daylight and the effects of weather.

This grey layer can be removed with a wood brightener applied using a stiff brush.

You can also apply a penetrating oil the same colour as the natural colour of the wooden.

A special oil may be more appropriate for tropical hardwoods, although the high density of some woodens may prevent penetration of the oil.

TECHNICAL SUPPORT

NEED HELP?



If you have any questions during the installation process, please contact our team. We will be happy to help you.



If you would like to plan out your decking or paving to calculate the number of riser pedestals you need, please use:

- The JOUPLAST mobile app.



You can find more information, including product technical information sheets and videos, on our website at www.jouplast.com

Follow us:



TMP CONVERT

546 Route of Bourg
01250 Simandre sur Suran
FRANCE

Tel. 04 74 25 84 84
Fax. 04 74 30 63 31

Contact Commercial - professionnels:
04 28 88 70 56
delphine.bailly@tmpconvert.com

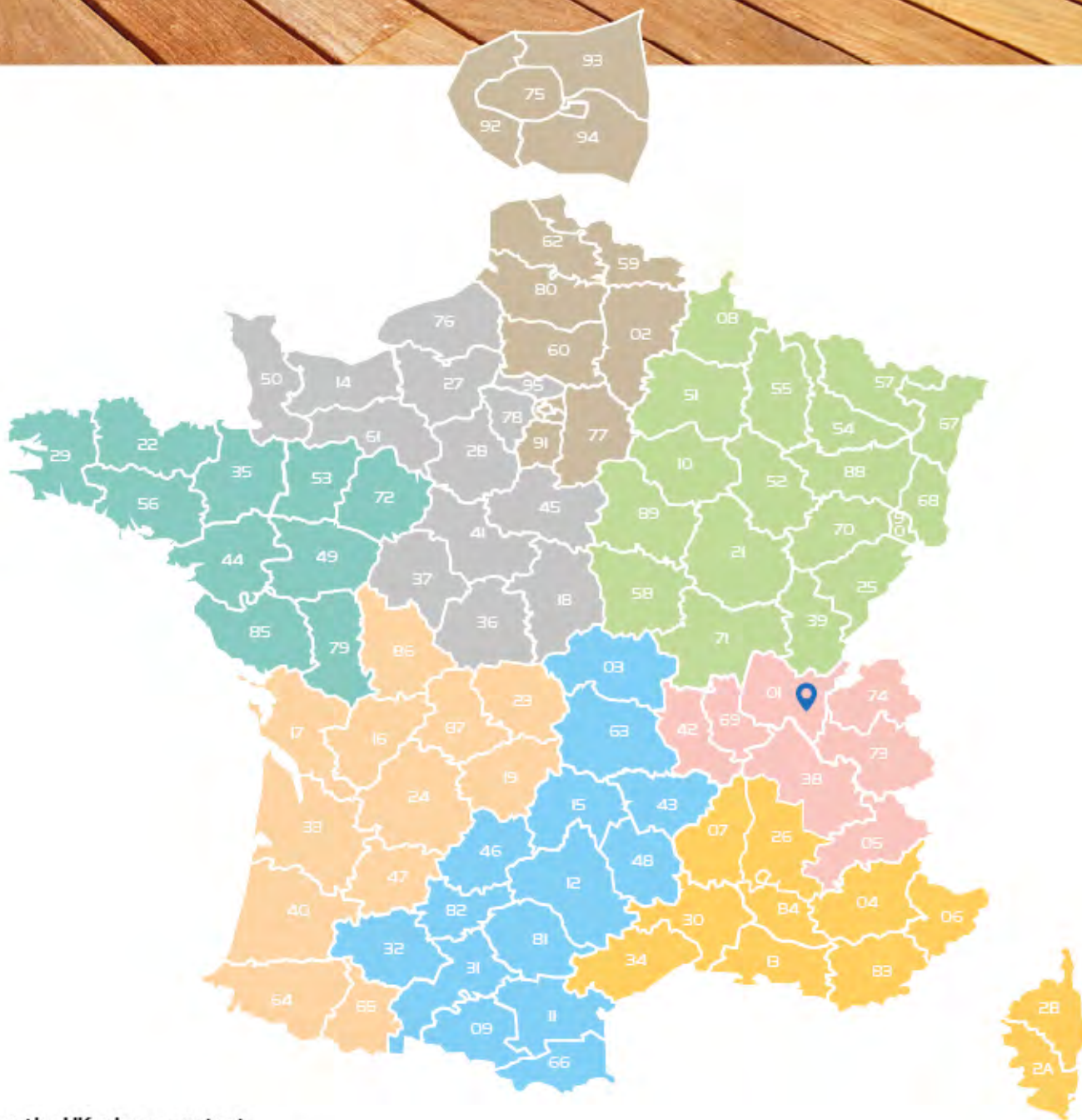

For the UK, please contact
PLASTIC MOLDING NORTHERN Plc -
+44 1388 777700
Contact : Freddy Bourdais - freddy@pmn-ltd.co.uk

LAYING ON RISER PEDESTALS

CALCULATE THE NUMBER OF RISERS YOU NEED PER M²

PAVING

SURFACE

SLAB DIMENSION	TYPE OF INSTALLATION	20 m ²	40 m ²	60 m ²	80 m ²	100 m ²	200 m ²	1 000 m ²
40 x 40 cm	1 riser per angle	7.8	7.2	6.9	6.8	6.8	6.6	6.5
45 x 45 cm	1 riser per angle	6.4	6	6	5.7	5.7	5.5	5.2
50 x 50 cm	1 riser per angle	5	4.7	4.6	4.5	4.4	4.3	4.1
60 x 60 cm	1 riser per angle	4	3.6	3.3	3.2	3.2	3.1	2.9
	1 riser per angle + 1 central riser	7.2	6.6	6.4	6.4	6.1	6	5.7
75 x 75 cm	1 riser per angle	2.8	2.6	2.3	2.3	2.3	2.1	1.9
	1 riser per angle + 1 central riser	4.9	4.7	4.2	4.2	4.2	4	3.8
80 x 80 cm	1 riser per angle	2.4	2.1	2.1	2	2	1.8	1.7
	1 riser per angle + 1 central riser	4.2	3.8	3.7	3.7	3.7	3.4	3.3
90 x 90 cm	1 riser per angle	2.1	2	1.7	1.7	1.7	1.6	1.3
	1 riser per angle + 1 central riser	3.6	3.5	3.1	3.1	3	2.9	2.6
45 x 90 cm	1 riser per angle + 1 riser along the longest length	6.4	6	6	5.7	5.7	5.5	5.2
100 x 100 cm*	1 riser per angle + 1 central riser + 1 riser on the sides	5	4.7	4.6	4.5	4.4	4.3	4.1
20 x 120 cm*	Not suitable for laying on risers, so please use PROFILDECK®.							
30 x 120 cm*	1 riser per angle + 1 riser along the longest length	7.5	6.8	6.3	6.3	6.3	6.1	5.8
40 x 120 cm*	1 riser per angle + 1 riser along the longest length	5.5	5	4.8	4.7	4.7	4.6	4.4
60 x 120 cm*	1 riser per angle + 1 riser along the longest length	4	3.6	3.3	3.4	3.2	3.2	2.9
120 x 120 cm*	1 riser per angle + 1 central riser + 1 riser on the sides	4	3.6	3.3	3.4	3.2	3.2	2.9

* For these formats, we recommend the use of a PROFILDECK® aluminium framed structure. Ask us about quantities.



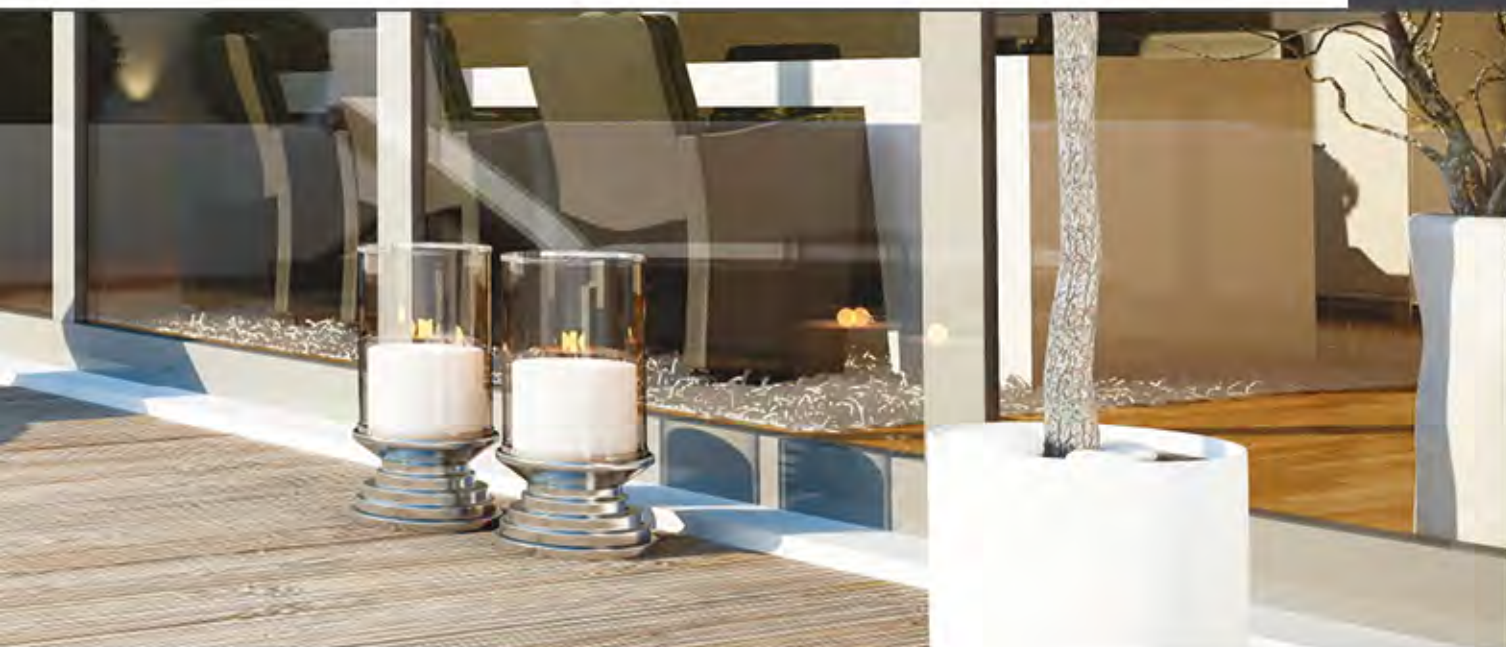

DECKING

SURFACE

LEDGER BOARD TYPE	TYPE OF INSTALLATION	20 m ²	40 m ²	60 m ²	80 m ²	100 m ²	200 m ²	1 000 m ²
LAME BOIS	Joist centre-to centre distance: 50 cm 1 riser per 70 cm under joist	4.1	3.9	3.7	3.5	3.4	3.2	3
	Joist centre-to centre distance: 50 cm 1 riser per 50 cm under joist	5	4.7	4.6	4.5	4.4	4.3	4.1
LAME COMPOSITE	Joist centre-to centre distance: 40 cm 1 riser per 70 cm under joist	4.6	4.6	4.4	4.2	4.1	3.9	3.8
	Joist centre-to centre distance: 40 cm 1 riser per 50 cm under joist	6.1	5.8	5.6	5.5	5.5	5.3	5.2

IMPORTANT: All riser pedestals must be used with wooden or metal joists, and NOT COMPOSITE joists.

RISER POSITIONING

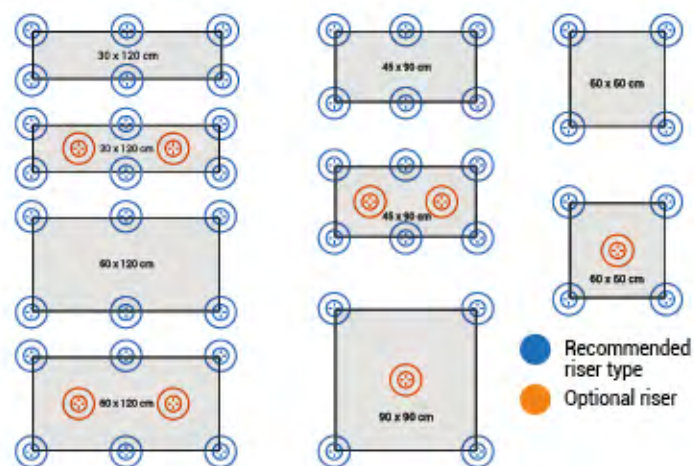

Please note: This information is provided solely for guidance, so please refer to the slab or tile manufacturer's recommendations regarding the number of risers to be used.

- This catalogue and its content are not binding and have no contractual value. Quantities are shown purely for guidance.
- Always follow paving manufacturer recommendations to ensure the suitability of paving products for use with riser pedestals and the number of risers per m² to use.
- Qualification of compulsory «SELF-SUPPORTING» slabs, of class T7, T11 or F + according to standard NF EN1339.



Creation  contact@leids.fr



«This document is copyright protected. Any reproduction, copying, abstraction or re-use in other publications and/or any translation, adaptation, display, distribution or modification, whether in full or in part, of its content is strictly prohibited and will be penalised, unless previously authorised in writing by TMP CONVERT. TMP CONVERT reserves the right to add, modify or delete information at any time and without prior notice.»
All photographs, diagrams and visuals are given purely as suggestions for use and have no contractual value.

DATA 2203



www.jouplast.com

